

To protect your METTLER TOLEDO product's future:
METTLER TOLEDO Service assures the quality, measuring accuracy and
preservation of value of all METTLER TOLEDO products for years to come.
Please send for full details about our attractive terms of service.
Thank you.



Subject to technical changes and to the availability
of the accessories supplied with the instruments.

© Mettler-Toledo GmbH 1999 11780223A Printed in Switzerland 9911/2.12

Mettler-Toledo GmbH, Laboratory & Weighing Technologies, CH-8606 Greifensee, Switzerland
Phone +41-1-944 22 11, Fax +41-1-944 30 60, Internet: <http://www.mt.com>

Operating instructions

METTLER TOLEDO MT/UMT balances

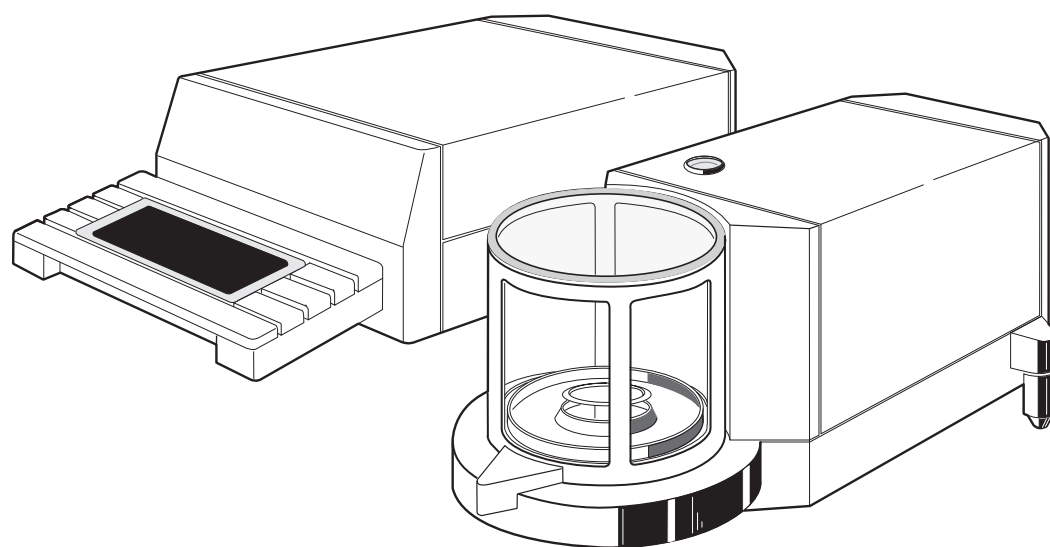

Operating instructions METTLER TOLEDO MT/UMT balances

Thank you for purchasing a METTLER TOLEDO MT/UMT microbalance.

The MT/UMT balances open up a new dimension in microweighing: They combine extreme precision and a wide range of weighing and setting options with an exceptional ease of operation.

Please read these operating instructions through carefully so that you can utilize all possibilities offered by your balance to the full. These operating instructions also offer valuable support in the form of a glossary and an index.

The present operating instructions apply to all METTLER TOLEDO balances of the MT/UMT series. As the various models have different performance characteristics, however, special mention is made in the text where this is important for the operation.

Please read through the enclosed booklet "Weighing the right way". It is intended as a supplement to these operating instructions and contains additional important tips and information.

If you fold out this page, you will have an overview of your balance that shows you all features at a glance.

Safety has priority



- It is essential you consult the instructions in section 1.2 regarding putting your new balance into operation.
- The MT/UMT balances may be operated only when connected to receptacle outlets with a ground connection.
- The MT/UMT balances must not be operated in hazardous surroundings.
- Never open the balance, it contains no parts which can be serviced, repaired or changed by the user. In the unlikely event you experience problems with your balance, please contact the responsible service facility.

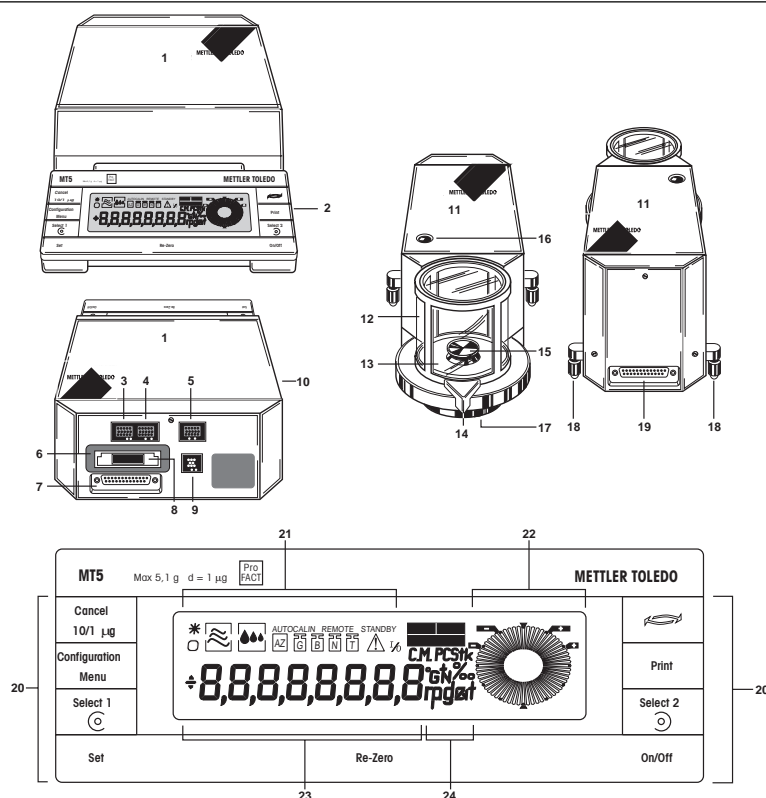

- 1 Evaluation unit
- 2 Keypad/display
- 3 Connection for foot or hand switch and electrical contacts
- 4 Connection for data interface
- 5 Connection to overhead display
- 6 Plug-in slot for program cassette
- 7 Connection for weighing cell
- 8 Program cassette, protection of the configuration parameters
- 9 Connection for AC adapter
- 10 Drawer with weighing tongs, brush and cleaning tweezers
- 11 Weighing cell
- 12 Glass draft shield with glass cover
- 13 Weighing chamber plate
- 14 Door handle
- 15 Weighing pan
- 16 Level
- 17 Hanger
- 18 Screw feet
- 19 Connection for evaluation unit
- 20 Function keys
- 21 Status indicators
- 22 DeltaTrac®
- 23 Digital display
- 24 Weight units

Operating instructions METTLER TOLEDO MT/UMT balances

Contents

	Page		Page
1 Your balance smooths the way	1	5 Special applications and functions of your balance	39
1.1 A new era in microweighing	1	5.1 Your balance can work with two weight units	39
1.2 Preparing your balance	2	5.2 Your MT/UMT also weighs in percent and displays plus/minus deviations	40
1.3 Weighing made simple	5	5.3 Do you wish to count pieces?	42
2 Your balance offers high-level operating convenience	9	5.4 How to trigger the adjustment manually	45
2.1 An ergonomic glass draft shield	9	5.5 How to check whether the balance is still adjusted correctly	48
2.2 The DeltaTrac® - an informative display	11	5.6 How to print out the weighing result	49
2.3 How you can weigh in the coarse and fine range	11	5.7 You can also operate your balance by remote control	50
3 Individual adaptation of your MT/UMT	13	6 Important information regarding your balance	51
3.1 What is the menu?	13	6.1 The AC adapter offers you a space-saving assembly option	51
3.2 How to adapt your balance to different types of weighing	17	6.2 If you change the location of your balance	53
3.3 How to adapt your balance to the local conditions	18	6.3 A well maintained balance is a joy forever	54
3.4 How to switch off the fully automatic door function	20	6.4 What your balance brings with it	55
4 Additional possibilities in the configuration register	21	6.5 Additional information and accessories for your balance	56
4.1 What is the configuration register?	21	7 Any questions?	56
4.2 How is the configuration register used?	22	7.1 What happens if the weight display is unstable?	56
4.3 In the first sector you return to the factory setting	25	7.2 How can the weighing speed be increased?	59
4.4 The second sector offers you numerous adaptation possibilities	26	7.3 What happens if...?	60
4.5 In the third sector you select the weight units and additional settings	31	7.4 What does this error message mean?	64
4.6 The fourth sector presents a communication-friendly balance	33	7.5 What does this term mean?	65
4.7 Print out the current configuration	37	7.6 How are weight units converted?	75
4.8 How to protect your settings against inadvertent changes	38	7.7 Where will I find details of...?	76
		Technical specifications	80

Operating instructions METTLER TOLEDO MT/UMT balances

Operating instructions METTLER TOLEDO MT/UMT balances

1 Your balance smooths the way

1.1 A new era in micro-weighing

The MT/UMT models open up new dimensions in microweighing, yet are simple to operate.

The separation of weighing cell and evaluation unit ensures maximum precision - disturbing thermal influences are practically eliminated. Automatic door functions facilitate operate and prevent vibrations. And there is no need whatsoever to concern yourself with the adjustment - your balance performs the adjustment fully automatically. Built-in data interfaces ensure that your balance can communicate with a computer and peripheral devices.

Your balance is distinguished primarily, however, by its user friendliness: You attach the weighing cell to the evaluation unit, connect the balance to the power supply and after 60 minutes warm-up time (with an acclimatized balance) you can immediately start weighing. You thus obtain your first weighing result in an extremely short time.

The MT/UMT microbalances offer you the operating convenience and the possibilities that to date were possible only with analytical balances. There is, however, no need for you to grapple at the moment with functions you will not need until later.

In this first section you will find out how simply you can start up your new balance and perform normal weighings.

1.2 Preparing your balance

If you fold out the front fold-out, you have in front of you an immediate overview of all general illustrations at a glance.

You need undertake the following operations only on first-time installation and each time you change the balance location.

Select a suitable location

Your balance expresses its thanks for an optimum location by providing you with excellent weighing results:



- Firm, vibration-free location, as level as possible

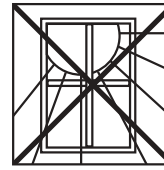

- No direct sunlight

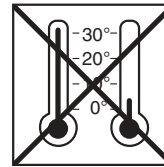

- No extreme temperature fluctuations

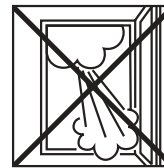

- No extreme fluctuations in the atmospheric humidity

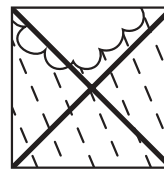

- No excessive drafts (e.g. due to powerful air conditioning units)

Additional tips and information regarding an optimum location can be found in the METTLER TOLEDO brochure - **“Weighing the right way”**, which is enclosed with your balance.

Unpack your balance

Your balance is dispatched to you in a rugged packaging that you should store in a safe place for possible future transport of the balance.

As soon as you have decided on a suitable location, remove all components of your new balance from the packaging.

Set up the balance

You can set up the weighing cell to the left or right of the evaluation unit. The flexible arrangement of the balance allows optimum adaptation to your method of working and to the available space.

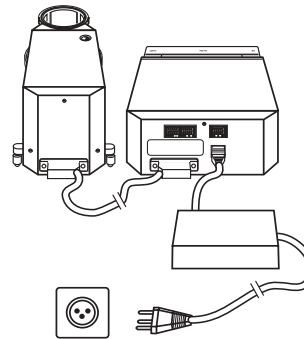

Connect the evaluation unit and the weighing cell

- Plug the supplied connection cable into connection socket **7** of the evaluation unit (marked with “For connection to weighing cell only”) and plug the other end into connection socket **19** of the weighing cell (marked with “For connection to evaluation unit only”). It is immaterial which end of the cable you connect to the evaluation unit or the weighing cell.
- The screws of the cable connectors have holes and can be sealed to prevent inadvertent separation of weighing cell and evaluation unit.

Mount the weighing pan and the draft shield

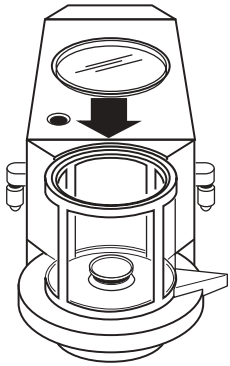

- The **MT balances** are supplied with mounted weighing pan. You thus only need to mount the glass cover on draft shield **12** of the weighing cell.
- The **UMT balances** have a smaller weighing pan than the MT balances (to avoid cornerload errors). The weighing pan is already mounted, on delivery. You thus need only mount the glass cover on the draft shield **12** of the weighing cell.

Level your balance

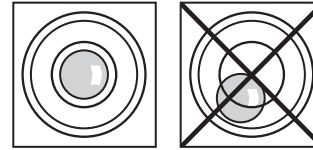

- Turn the two screw feet **18** at the rear of the weighing cell housing until the air bubble is in the middle of level **16**.

Connect your balance to the power supply

- Connect the AC adapter supplied to connection socket **9** at the rear of the evaluation unit and then to the power supply.
- The AC adapter can either be placed on the bench or, to save space, mounted on the wall. The AC adapter holder and the installation set with dowels and screws are used for this. Appropriate details are given in Section 6.1.

STANDBY

After connection, your balance is on **standby**. If your balance is already acclimatized (depending on the temperature difference between the old and new location, this takes 6 to 12 hours), it provides you with the first reliable results after 60 minutes warm-up time. After approximately 2 hours you can count on very accurate weighing results.

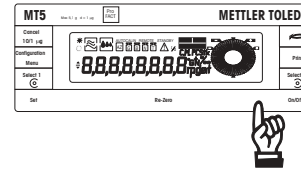



1.3 Weighing made simple

- By pressing the «**On/Off**» key you switch your balance from standby to the **weighing mode**. The balance now automatically performs a brief self-test and all display segments light up briefly.

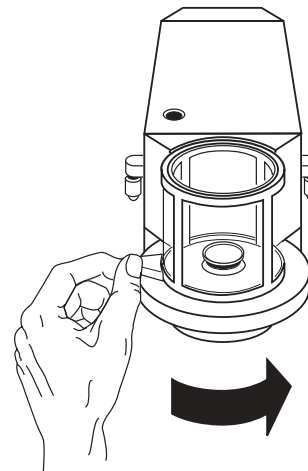
At the end of the self-test, the balance determines the zero point. This very precise measurement takes several seconds, depending on the stability and acclimatization of the balance.



- If the draft shield is open, you can close it by pressing one of the two keys  or  or manually by turning door handle **14**.

Your balance is fitted with a fully automatic door function, which ensures that the draft shield is always open or closed at the right time. Section 3.4 describes how you can switch off this automatic mechanism. On completion of the self-test, this function opens the draft shield completely automatically.

Set your balance to zero (taring):

- If you wish to tare a container, place it on the balance.
- Press the «**Re-Zero**» key. The fully automatic door function closes the draft shield.

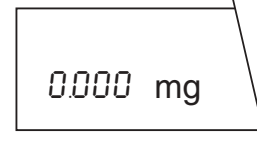
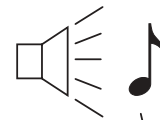
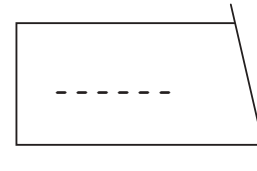
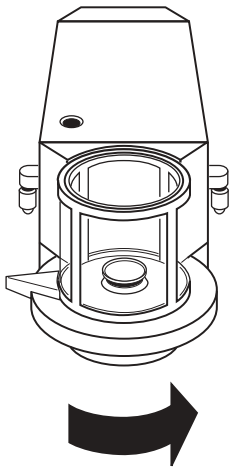

Zeroing of the display (taring) is automatic. While the zeroing is in progress and the horizontal segments appear in the display, you can abort the process by briefly pressing the «**Re-Zero**» key again.

As soon as the warning beep sounds, zeroing of the balance is complete and the fully automatic door function opens the draft shield.

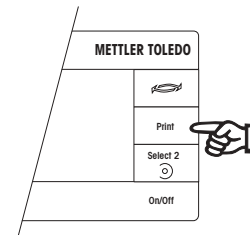

- Load the weighing sample and press the «**Print**» key. The fully automatic door function closes the draft shield.

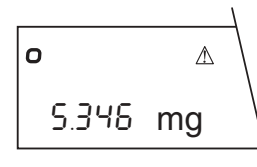

The triangle symbol (print symbol) and the circle symbol of the stability detection (ASD) appear in the display.

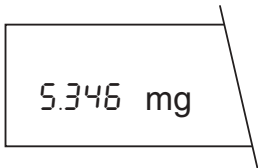

- When the symbol of the stability detection (ASD) fades, the warning beep sounds; the triangle symbol also fades and the draft shield opens automatically.

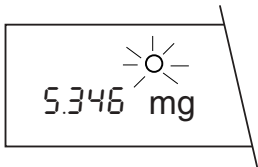

- Read off the weighing result. The result remains “frozen” on the display for 5 seconds. This can be recognized by the flashing circle above the weight unit. If the balance is attached to a printer, the weighing result is automatically printed out.

With this automatic door function, your work steps in weighing are reduced from 9 to 5!

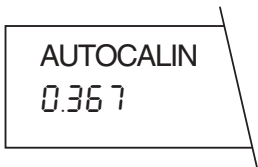

It is possible that the warning beep sounds during a weighing and the adjacent symbol appears in the display. Your balance uses this to show that it would like to adjust itself. But there is no need for you to interrupt your work as the balance waits until you have not carried out any weighings for a period

of about 5 minutes and then performs the **fully automatic self-adjustment** (proFACT = **F**ully **A**utomatic **C**alibration **T**echnology).

The symbol remains lit up until the balance has adjusted itself or until you trigger the adjustment by a keystroke. Section 5.4 shows you how to trigger the adjustment yourself.

- For **switching off the balance**, lift up the «**On/Off**» key briefly from below. This closes the draft shield automatically if the fully automatic door function is switched on. Otherwise, close the draft shield manually to prevent the ingress of dust and dirt.

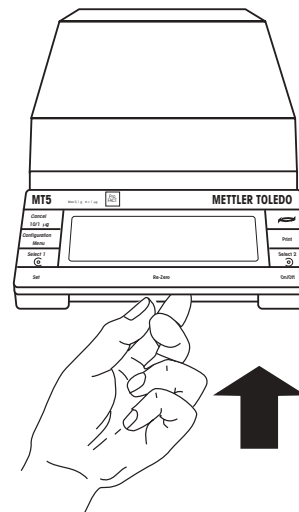

After being switched off, the balance is on **standby**. When it is switched on again, it needs no warm-up time and is in immediate operational readiness.

Some additional tips:

- If you have made a mistake during weighing, there is no need to worry: Simply switch off your balance briefly and then switch it on again. You will later learn of other possibilities to bring your MT/UMT to weighing readiness again.
- You can also effect the zeroing (taring) of the balance using the **foot or hand switch** (available as an accessory) attached to the balance via connection **3**. Operation with the foot switch leaves both your hands free for loading the balance.
- If you ever have to disconnect your balance from the power supply, first switch it off by lifting up the «**On/Off**» key. After the balance has been reconnected, it is in the standby mode and “*STANDBY*” appears in the display.

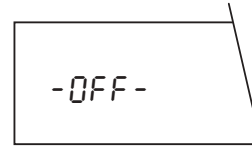
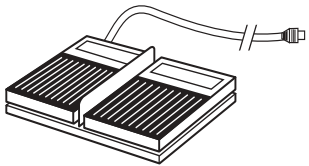

After an unexpected power outage, however, or if you did not switch off your balance before disconnecting it from the power supply, when power is restored again “-OFF-” appears in the display. When the «**On/Off**» key is now pressed in such a case, an extended, internal self-test is first performed. Here the model designation and the software version are briefly displayed and all display segments light up for a short space of time.

2 Your balance offers high-level operating convenience

2.1 An ergonomic glass draft shield

The small, circular glass draft shield reduces the contact surface for disturbing thermal influences and thanks to the narrow framework allows an unrestricted view of the weighing sample.

The weighing chamber can be opened at the left or right. The balance is thus equally convenient to load for left- and right-handers.

You can operate the draft shield **manually** in the traditional manner using door handle **14**.

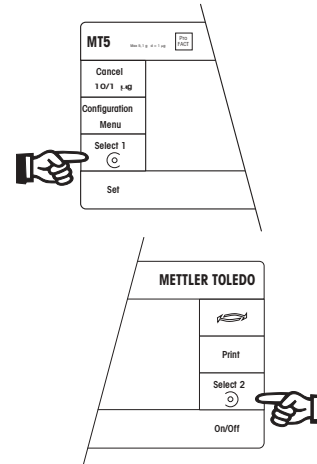
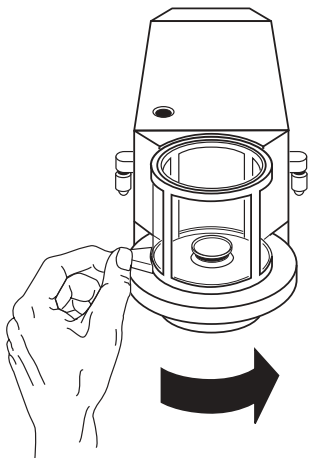

The **semiautomatic** operation can be effected either with the ⏪ or ⏩ key. In this case, the draft shield is opened and closed by the motor either to the right or left.

- In one-handed operation, you use one hand to press the ⏪ or ⏩ key and then load the balance using the same hand.
- In two-handed operation, you press the ⏪ or ⏩ key with one hand and load the balance using the other hand.

In certain applications, such as zeroing (taring) of the balance, the draft shield opens and closes **fully automatically** as you already know from your first weighing. Manual or semiautomatic operation is also possible when the fully automatic door function is operative.

The fully automatic door function primarily facilitates work with the single or twin foot switch. Section 3.4 shows you how to switch off the fully automatic door function.

The draft shield of your balance has a “**Learn function**”. If the fully automatic door function is in operation, the draft shield opens automatically when the balance is zeroed and when the weighing result is printed out **on the side you desire**. For this purpose, the balance notes which of the keys \odot or \ominus you last pressed to open or close the draft shield.

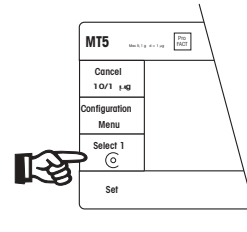

An example:

You used the \odot key, which opens the draft shield **to the right**, for the last door opening.

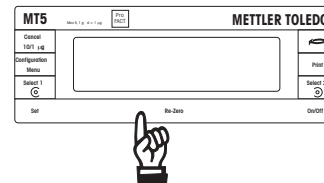

You now wish to zero the balance and press the «**Re-Zero**» key for this.

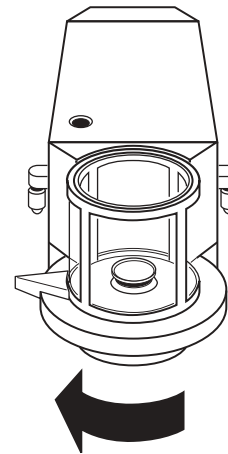

The draft shield is closed automatically and when zeroing is complete opens again **to the right**. However, if you wish the draft shield to open **to the left**, you must press the \ominus key before triggering zeroing.

2.2 The DeltaTrac® - an informative display

The DeltaTrac® **22** is a supplement to the digital display **23**. It provides you with a pictorial representation of **the weighing range in use and that still remaining**. The dynamics of a weighing process can be followed on the DeltaTrac® extremely well. Simply observe the DeltaTrac® during a weighing and you will immediately understand its function.

The DeltaTrac® gives you a new feel for weighing, even with special applications, for example in repeated weighing in to a specified target value and in percent weighings. You will find further details in Section 5.2.

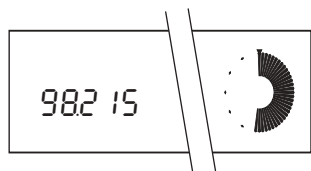
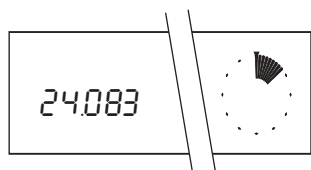

2.3 How you can weigh in the coarse and fine range

Your balance is equipped with a switch key which you can use to switch from the ten times more accurate fine range to the coarse range.

This switching allows you to work in the range best suited to your needs.

If, for example, instead of a high resolution you need a stable weighing result as rapidly as possible, you switch from the fine range to the coarse range using the switch key. This makes your balance very fast and the weighing results are extremely stable.

You have the following selectable ranges available:

Balance	Fine range	Coarse range	Key
MT5	1 μg	0.01 mg	10 / 1 μg
UMT2	0.1 μg	1 μg	1 / 0.1 μg
UMT5	0.1 μg	1 μg	1 / 0.1 μg

With the «10/1 μg » key of the MT balance or the «1/0.1 μg » key of the UMT balance, you can switch between the fine range and the coarse range:

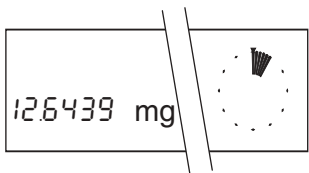

- The balance is measuring in the fine range

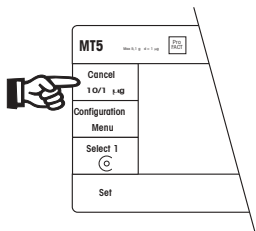

- Press the «10/1 μg » (or «1/0.1 μg ») key and...

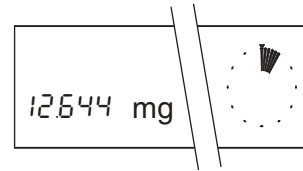

- ...the balance operates in the coarse range.
- By pressing the «10/1 μg » (or «1/0.1 μg ») key again, you can return to the fine range.

3 Your balance is an adaptable balance

For the optimization of your weighing results and adaptation to your weighing needs, your balance offers you additional setting options. You undertake these adaptations in the **menu**, which you will now be introduced to.

You can set additional parameters in the second menu tree of your MT/UMT, the configuration register (section 4).

3.1 What is the menu?

In the menu you match your balance to the local conditions and to the weighing tasks. The menu contains various adaptation possibilities, the menu options, which in turn offer different setting options.

Overview of the menu functions:

- reference weight in %
- reference weight in pieces
- adjustment
- weighing process adapter
- vibration adapter
- fully automatic door function

You will find a detailed overview of the menu on pages 78 and 79.

In addition, you can also perform several operational steps in the menu for special applications (percent weighing and piece counting). Section 5 of these operating instructions provides you with more information.

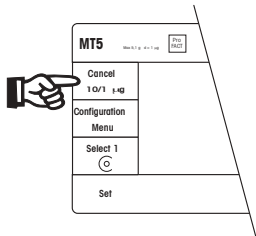

We encourage you to **experiment** with the menu to familiarize yourself with it. **You need have no worries here: By pressing the «Cancel» key you can return to the weighing mode at any time without changing any of the stored settings!**

You perform your weighings in the **weighing mode**, the operational mode of your balance. **Weighing mode** and **menu** are separate. By pressing and holding the «Configuration» key you can call up the configuration register. You can also select the different menu options and setting possibilities with keystrokes.

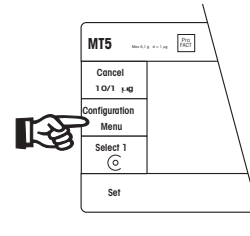

«Menu» key

- Selection of the **menu** by **briefly** pressing the key in the weighing mode
- Selection of the individual **menu options**

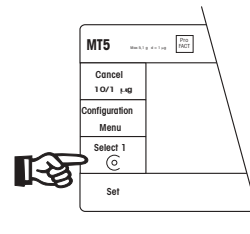

«Select 1» key

- Selection of the **setting** in a menu option

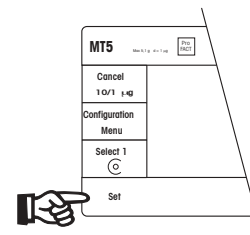

«Set» key

- **Confirmation** of your selection and return to the weighing mode. The selected settings are stored and remain so even after the balance has been switched off.

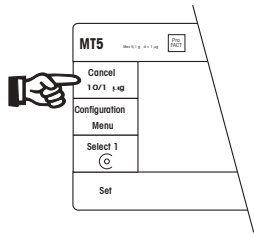

«Cancel» key

- **Exit** the menu and return to the weighing mode **without any changes** being made. If you have made a wrong selection, you can leave the menu **at any time** by pressing the «**Cancel**» key. You are then in the weighing mode again **without any change in the settings**. Instead of pressing the «**Cancel**» key, you can naturally switch the scale off briefly and then on again.

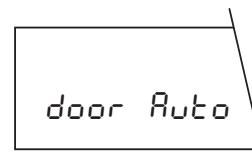
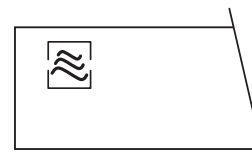
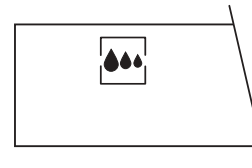
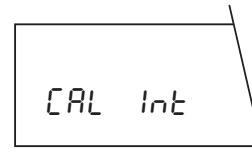

By repeated pressing of the «**Menu**» key, all available menu options appear in the display in succession:

- proFACT
fully automatic adjustment and linearization
- Adaptation to the type of weighing (weighing process adapter)
- Adaptation to the local conditions (vibration adapter)
- Automatic door function of the draft shield

A complete overview of the menu can be found on pages 78 and 79.

Some additional tips:

- Not all menu options are constantly or exactly displayed in the form shown; some of them, e.g. the setting of reference weights (“Set 100%”) depend on additional settings in the configuration register, which we will introduce you to in Section 4 of these operating instructions.
- If you are in the menu and **press no key for about 1 minute**, the balance **returns automatically to the weighing mode**. Any changes in the settings made up to this point are ignored in this case.

- In the following 3 sections you will get to know three menu options (weighing process adapter, vibration adapter and automatic door function) in detail. The additional setting options for special applications (weighing in reference weights for percent weighings or piece counting and the adjustment) will be introduced in Section 5.

3.2 How to adapt your balance to different types of weighing

Your balance can be matched to different types of weighing (fine dispensing, absolute weighing, etc.) very simply. For this purpose, it is equipped with the so-called **weighing process adapter**, which can be set in the menu.

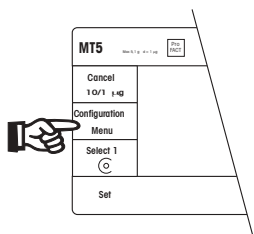

- Select the menu by pressing the «**Menu**» key briefly.



- Press the «Menu» key repeatedly until the drop symbol of the weighing process adapter appears in the display.

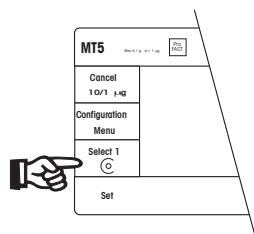

- Select the appropriate setting with the «**Select 1**» key:



This is the **universal setting** suitable in principle for all types of weighing. This setting is preset in the factory.



The setting **absolute weighing** is suitable for the rapid checking of a weight. During the weighing in, the last decimal place is suppressed.



If you wish to employ fine dispensing (weighing in) of a fine powder or small amounts of liquid, select the **weighing in** setting. This provides a continuous display of all decimal places, and the weight increase can thus be followed easily.

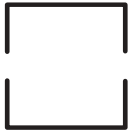

In this position the drop symbol is invisible, the weighing process adapter is switched off. This setting is **suitable only for special applications** in which not only the final result but also the dynamics of the weighing process are of interest, for example the recording of weight changes due to evaporation against time.

- When you have selected the appropriate setting, press the «**Set**» key. This makes the selected settings active immediately, and the balance returns to the weighing mode.

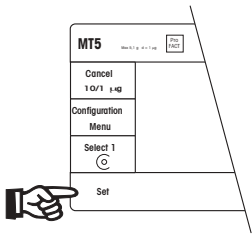

3.3 How to adapt your balance to the local conditions

If, despite a closed draft shield, no stable weighing results are found, the cause could lie with unfavorable local conditions such as vibrations. Very minor, hardly noticeable vibrations of the weighing table are usually involved.

With the so-called **vibration adapter** your balance can be matched in the menu to the local conditions.

- Select the menu.

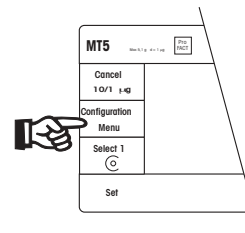

- Press the «**Menu**» key repeatedly until the wave symbol of the vibration adapter appears in the display.

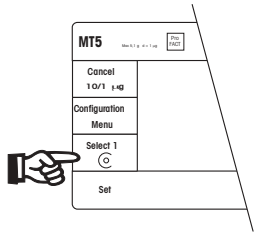

- Select the appropriate setting with the «**Select 1**» key:



This setting is suitable for **normal ambient conditions**; the balance operates at **moderate speed** in this case. This is the factory setting.



This setting is suitable for work in **unstable surroundings**. The balance operates **more slowly**, but is less sensitive to external disturbances.



This setting is suitable for **very calm and stable surroundings**. The balance operates **very rapidly**, but is relatively sensitive to external disturbances. This setting is recommended if your balance is located on a stone table.

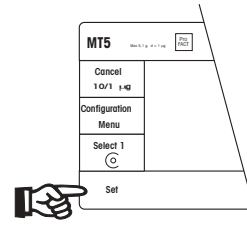

- When you have selected the appropriate setting, press the «**Set**» key. The chosen setting then immediately becomes active, and the balance returns to the weighing mode.

Note:

A further reason for an unstable display of the weighing result could lie, for instance, with electrostatic charging of the weighing sample or the container. You will find additional information regarding this in Section 7.1.

3.4 How to switch off the fully automatic door function

You are already familiar with the convenient automatic door function of your balance from your first weighing. When the automatic door operation is switched on, the draft shield closes automatically after the «**Re-Zero**» key (zeroing/taring) or the «**Print**» key (printout of the weighing result, see Section 5.6) has been pressed. As soon as the weight display is stable, the draft shield is reopened for the next weighing operation (e.g. weighing in, loading the balance). The draft shield is thus always in the correct position for the next weighing process. Routine work is particularly facilitated by this automatic operation. It is also useful in the percent weighing (Section 5.2) and piece counting (Section 5.3) applications.

When the twin foot switch is used, the automatic operation leaves **both** hands free for weighing in.

If you wish to operate the draft shield manually or semiautomatically using the two keys \odot and \ominus , however, you can **switch off the automatic door operation**:

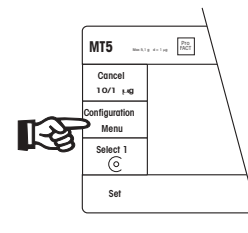

- Select the menu.



- Press the «**Menu**» key repeatedly until the adjacent display appears.

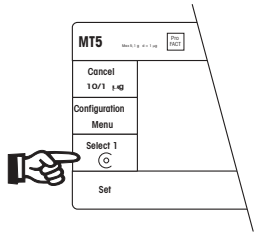

- Using the «**Select 1**» key, you can now switch the automatic door operation off and on again:



Fully automatic door function switched on

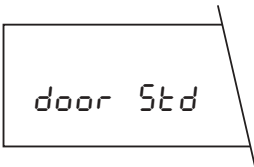

Fully automatic door function switched off

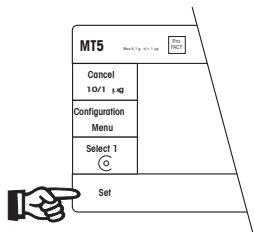

- Activate the chosen setting by pressing the «**Set**» key and you will be returned once again to the weighing mode.

4 Additional possibilities of your balance

In addition to the menu, your MT/UMT balance offers you further, very specific adaptation possibilities. You perform these adaptations in the **configuration register**, which we will introduce you to in the following section.

4.1 What is the configuration register?

The configuration register is divided into four sectors in which you can vary the following settings:

- Operational setting
 - Reset
- Basic settings
 - ASD, automatic stability detector
 - Readability
 - Readability in the semimicro range
 - Autozero
 - proFACT, adjustment and linearization

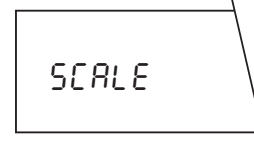
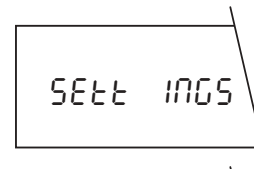

Unit

- Weighing units
 - weighing unit 1
 - weighing unit 2
 - status indicator
 - beeper

Int -FACE

- Interface
 - data transmission mode
 - data transmission rate
 - parity
 - transmission protocol
 - end-of-line mode

You will find further details on the adjustment parameters on pages 78 and 79.

4.2 How is the configuration register used?

Hold the short-form operating instructions in your hand. You will then have the complete configuration register in front of you at a glance.

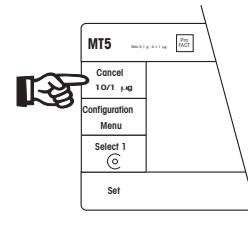

We would like to encourage you **to experiment** with the configuration register to familiarize yourself with it. **You need have no worries on this score: By pressing the «Cancel» key, you can return at any time to the weighing mode without any of the stored settings being altered!**

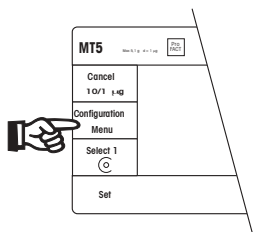
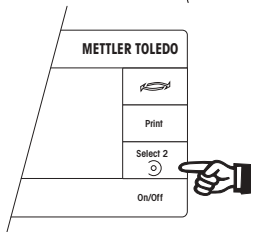
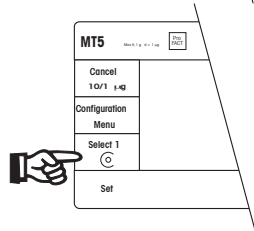
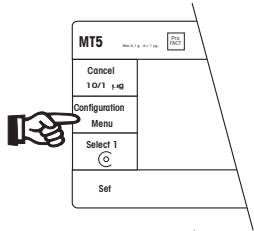

By pressing and holding the «**Configuration**» key, you call up the configuration register. You select the different

- sectors («Configuration» key)
- parameters («Select 1» key)
- settings («Select 2» key)

by simply pressing the appropriate key. In contrast to the menu, you also need the «**Select 2**» key for operation of the configuration register.

«**Configuration**» key

Selection of the **configuration register** from the weighing mode by **pressing and holding** the key (about 5 seconds). You are then already in the first sector.

Selection of the individual **sectors** in the configuration register with a brief keystroke. After the last sector you are returned to the first.

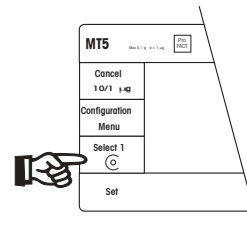

«**Select 1**» key

Selection of the **parameters** in a sector. After the last parameter in this sector you are returned to the first.

«**Select 2**» key

Selection of the desired **setting** of a parameter. After the last setting of a parameter, you are returned to the first.

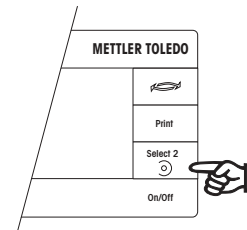

«**Set**» key

Confirmation of your selection and return to the weighing mode. The selected settings are stored and remain so even after the balance has been switched off or disconnected from the power supply.

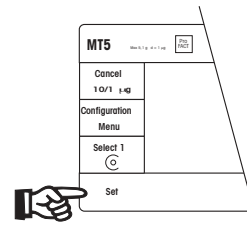

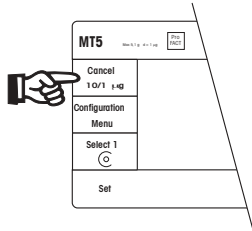

«Cancel» key

Exit the configuration register and return to the weighing mode **without** any **changes** being stored. If you have made a wrong selection, you can quit the configuration register **at any time** by pressing the «**Cancel**» key. You are then again in the weighing mode **without any setting having been altered**. Instead of pressing the «**Cancel**» key, you can also switch the balance off, then immediately on again.

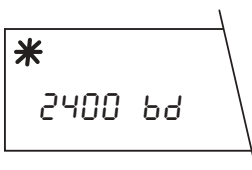

Your balance is naturally not supplied with an empty configuration register. We have already included **default settings** for you. You can recognize these **factory settings** by the **asterisk** in the upper left corner of the display.

A further tip:

If you are in the configuration register and you do not press a key for about 1 minute, the balance automatically returns to the weighing mode. In this case, any alterations in the settings are ignored.

In the following sections you will learn what parameters you can select in what sectors, and what settings are available. You will find the **first example** in the **setting of the parameter “Automatic stability detection” (ASD)** in Section 4.4. In the following sections, you will also find recommendations for the correct setting of your balance. Further useful tips are contained in the enclosed booklet “Weighing the right way”.

4.3 In the first sector you return to the factory settings

As you have learned in the preceding section, the configuration register of your balance has been preset in the factory. Even if you have modified the settings, you can return to the factory setting at any time.

But here all specific settings, even those in the menu, will be replaced by the factory settings!

You undertake the return to the factory settings in the first sector (operational setting). This sector contains only a single parameter:

- Select the configuration register by pressing and holding the «**Configuration**» key. As soon as the display shown opposite appears, release the key.

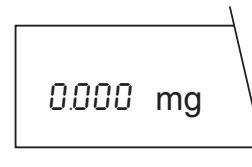
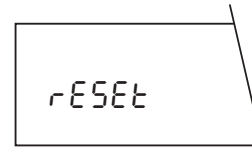
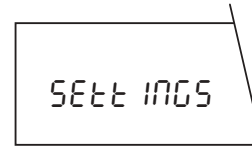
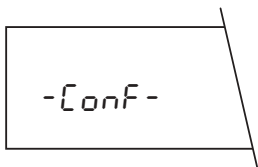

- You are now in the first sector (*Settings*) of the configuration register.
- Select the first (and only) parameter («**Select 1**» key).
- Activate the resetting by pressing the «**Set**» key, and the scale returns automatically to the weighing mode. You again work with the factory settings.

4.4 The second sector offers you numerous adaptation possibilities

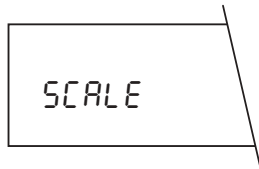

- Select the configuration register by pressing and holding the «**Configuration**» key. Then select the second **sector** (basic settings) by pressing the «**Configuration**» key briefly.

In this sector you can select the following **parameters** and their settings:

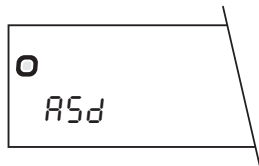

Automatic stability detection, (ASD)

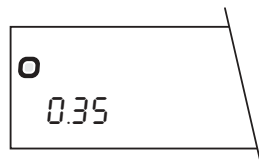

Your balance possesses an automatic stability detection. As long as the weighing result is **unstable**, the stability detection symbol remains lit up in the upper left corner of the display.

The symbol fades and the weighing result is released only when the result is within the limits selected by you for the stability.

You have a choice of eight settings. In the setting *ASd-1*— the display must be within a preset tolerance limit for **one second** for the result to be released as stable. In the setting *ASd-7*— the result must be within a preset tolerance limit **for several seconds** before being released.

- Select the first parameter, the automatic stability detection (*ASD*), with the «**Select 1**» key.
- Select the appropriate setting with the «**Select 2**» key. The following illustration shows the relationship between the repeatability and the weighing speed.

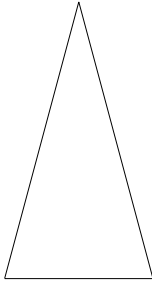
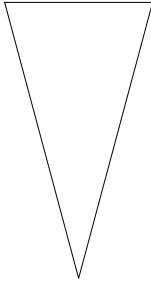
Stage	Weighing speed	Repeatability
off	very fast	good
1		
2		
3*		
4		
5		
6		
7		
	fast	very good

*= factory setting

In the *oFF* position, the balance does not wait for attainment of stability; each result is considered stable. This setting is used in special applications in connection with the serial data interface (see also Section 4.6 “Data transmission mode”).



Readability (selection of the readout increments)

In this parameter you define the readout increments (digits) for the last decimal place. Readout increments of 1, 2, 5 and 10 are available, and these are symbolized by the following setting options:

MT5	UMT2	UMT5
0.01 mg*	1 µg*	1 µg*
0.02 mg	2 µg	2 µg
0.05 mg	5 µg	5 µg
0.1 mg	10 µg	10 µg

* = factory setting

Select readout increments as large as your application allows; the larger the readout increments, the faster the operation of your balance.

dF

Readability (selection of the readout increments) in the fine range

Here you define the readout increments (digits) for the last decimal place for weighings in the fine range. Readout increments of 1, 2, 5 and 10 are available, and these are symbolized by the following setting options:

MT5	UMT2	UMT5
1 µg*	0.1 µg*	0.1 µg*
2 µg	0.2 µg	0.2 µg
5 µg	0.5 µg	0.5 µg
10 µg	1 µg	1 µg

* = factory setting

Select readout increments as large as your application allows; the larger the readout increments, the faster the operation of your balance.

With the «**10/1 µg**» (or «**1/0.1 µg** with the UMT) key, you toggle between the coarse and fine range.

AZ

Autozero (AZ)

In this parameter you switch the automatic zeroing (autozero) on or off. When switched on, the zero is automatically corrected for drift or contamination of the weighing pan.

- Autozero on*

AZ

on

- Autozero off

AZ

off

* = factory setting

For particular applications (e.g. monitoring of the zero point in long-term weighings), it can be an advantage to switch the autozero function off.

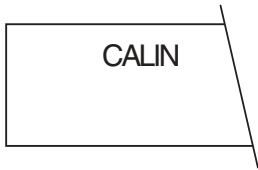

Adjustment and linearization with proFACT

In this parameter you define the adjustment mode, i.e. the way in which your balance should be adjusted and linearized. The following possibilities are available:

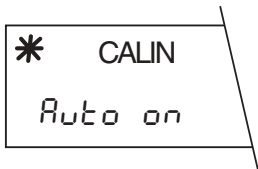

- The MT/UMT balance adjusts and linearize itself **fully automatically** by loading two internal adjustment weights. The process is initiated as soon as a change in the operating conditions makes this necessary. One of the most important initiation criteria is a temperature fluctuation in the surroundings of $\pm 1.5\text{ }^{\circ}\text{C}$. You do not have to concern yourself with the adjustment of the balance. The adjustment and the simultaneous linearization provide you with the surety that the displayed value matches the mass of the loaded weight over the entire weighing range of your MT/UMT.

proFACT professional fully automatic adjustment and linearization technology

1. Adjustment

The two internal adjustment weights are loaded. The display is adjusted so that the loaded weight matches the displayed value. (Correction of the slope of the straight line).

2. Linearity

The internal weight m_1 is loaded alone and together with the weight m_2 . The linearity is adjusted using the different display values for m_1 in both measurements. If the two displayed values, y_1 and y_2 , are equal, the linearity is adjusted. (Correction of the deviation from the shape of an ideal straight line).

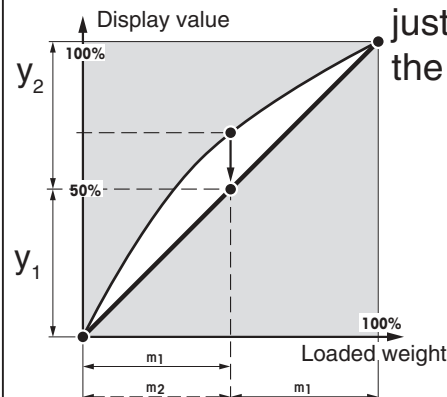

CALIN
Auto off

In this mode you can also initiate the fully automatic adjustment and linearization at any time with a key-stroke. This is practical, for instance, when your balance reports during a weighing that it wishes to adjust itself. Section 5.4 shows you how to proceed in such a case.

- The fully automatic **self-adjustment with linearization adjustment (proFACT)** described above is **switched off**. You can trigger the adjustment with the internal adjustment weights **at a keystroke**. After initiation, the adjustment runs automatically, and at the same time the measuring range is linearized. Section 5.4 shows you how to proceed in this case.

CAL
USER

- You use your **own, external adjustment weight** for the adjustment. The procedure is described in Section 5.4 of these operating instructions. proFACT is not active in this setting.

4.5 In the third sector you select the weight units and additional settings

Select the third sector (weight units) in the configuration register.

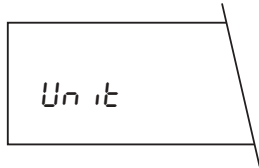

In this sector you can select the following parameters and their settings:

Weight unit 1

The following weight units are available:

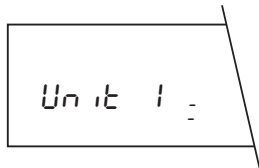

Display	Name
g	gram
mg *	milligram
µg	microgram
GN	grain
dwt	pennyweight
ct	carat, metric
C.M.	carat, metric (GB)
mo	momme

* = factory setting

The number of decimal places in each unit is dependent on the balance model.

By pressing the  key, you toggle between weight unit 1 (*Unit 1*) and weight unit 2 (*Unit 2*). Section 5.1 provides you with further details regarding this switching. A conversion table for the weight units is given in Section 7.6.

Weight unit 2

You have available the same weight units as with weight unit 1 and also the **application units piece and percent**:

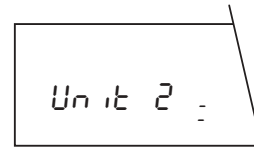

Display	Name
g	gram
mg	milligram
µg *	microgram
GN	grain
dwt	pennyweight
ct	carat, metric
C.M.	carat, metric (GB)

mo	momme
PCS	pieces
Stk	pieces (German)
%	percent

* = factory setting

The number of decimal places in each unit depends on the balance model.

By pressing the  key, you toggle between weight unit 1 (*Unit 1*) and weight unit 2 (*Unit 2*). You will find further details in Section 5.1. A conversion table for the weight units is given in Section 7.6.

The application units «piece» and «percent» are described in detail in Sections 5.2 and 5.3.

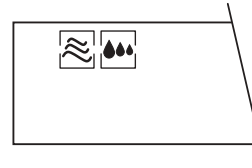

Status indicators

The status indicators **21**, such as the symbols for the vibration adapter and the weighing process adapter, provide you with an overview of the selected settings. These graphic indicators can be switched on or off.

- A few minutes after the balance has been switched on, the symbols fade. *

- The symbols are displayed permanently.

* = factory setting



bEEP

Beeper setting

The audio acknowledgement beep supports the operation of the balance and the display audibly. You can switch it off or on.

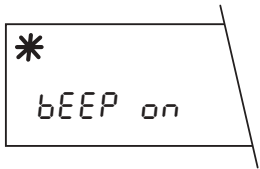

*
bEEP on

- audio acknowledgement beep switched on *



bEEP off

- audio acknowledgement beep switched off

* = factory setting

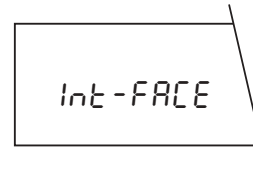

Int-FACE

4.6 The fourth sector presents a communication-friendly balance

- Select the fourth sector in the configuration register (interface).

For the attachment of a third-party printer or a PC you can select the parameters for the data transmission via the serial data interface and their settings in this sector. You will find more detailed information regarding use of the interface in the instructions “**Bidirectional interface of the METTLER TOLEDO AT/MT/UMT balances**”, which is enclosed with your balance.

Data transmission mode

The following setting options are available:

S.

- **Send stable:** The **first stable value** is transferred after initiation of the print command after release by the automatic stability detection. *

*

S. Stb

- **Send all:** The **current value** is transmitted after initiation of the print command.

S. ALL

- **Send automatically:** The **first stable value** is transmitted automatically **after every weight increase of at least 0.01 g.**

S. Auto

- **Send continuously:** **All prepared values** are transmitted continuously.

S. Cont

* = factory setting

Important note:

If you have switched off the automatic stability detection in sector 2 (*ASD OFF*), all weight values are regarded as being stable. After the «Print» key has been pressed in this case, the following values are transmitted:

In setting *S.Stb*: The current value as in the setting *S.ALL*.

In setting *S.Auto*: The first value after a weight change of more than 0.01 g.

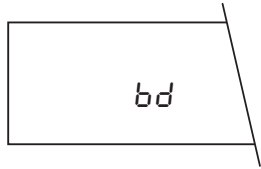

Data transmission rate (baud rate)

The data transmission rate (baud rate) determines the speed of the transmission via the serial interface. The unit is the baud (1 baud (bd) = 1 bit/second). The following transmission rates are available:

- 150 db
- 300 db
- 600 bd
- 1200 bd
- 2400 bd *
- 4800 bd
- 9600 bd

* = factory setting

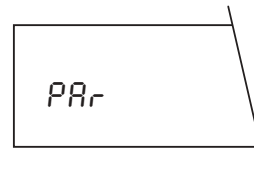
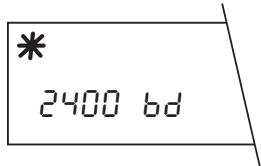

Parity

With the aid of the parity test, simple bit errors in the data transmission can be recognized by a parity check. The following setting options are available:

- **Parity Even** *

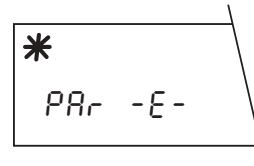

- **Parity Odd**

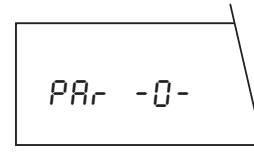

- **Parity Off**

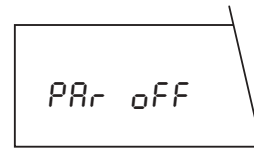

- **Parity Space**

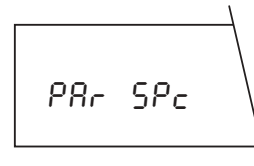

* = factory setting

HS

These settings allow matching of the data transmission to various serial receivers. The following settings are available:

*
HS PAUSE

- Pause of 1 second (for METTLER TOLEDO GA42 Printer)*

HS CL

- METTLER TOLEDO transmission protocol. In this operating mode, the end-of-line mode is automatically set to "crLF" and can not be changed.

HS OFF

- No handshake

HS HARd

- Hardware handshake (DTR/CTS)

HS SoFt

- Software handshake (XON/XOFF)

* = factory setting

EOL

End-of-line mode

Two setting options are available:

*
EOL crLF

- Carriage return and line feed at end of line *

EOL cr

- Carriage return at end of line

* = factory setting

Important note:

If *HS CL* is set in the transmission protocol, the end-of-line mode is set automatically to *EOL crLF* and can not be changed.

4.7 Print out the current configuration

You can print out the configuration currently stored on an attached printer. This record is useful if you work with different configurations. You then know at all times which values should be set for which application.

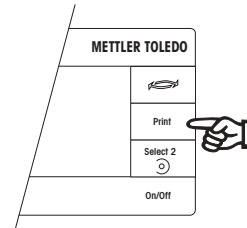

Proceed as follows for the printout:

- Select the configuration register.
- Press the «Print» key, and the current configuration will be printed out.

```

STD 10.1.11
TYPE : MT 5
1.00.00

= STORED SETTINGS =

-SCALE-
ASD           : 3
d (Step)      : 1
dF (Step)     : 1
AutoZero      : on
Cal           : auto on

-UNIT-
Unit 1        : mg
Unit 2        : ug
Symbols       : auto
Sound         : on

-INTERFACE-
Send Mode     : stb
Baudrate      : 2400
Parity        : even
Handshake     : Pause
Line End      : CRLF
=====
    
```

A further tip: Always print out your specific configuration. You thus have a record of your settings and even if you return to the factory settings, you can restore your configuration at any time.

4.8 How to protect your settings against inadvertent change

As you know, with one press of the «**Set**» key your individual settings in the configuration register are stored. These are available at any time (even if the balance has since been disconnected from the power supply). You are not, however, protected against inadvertent alterations, for instance by other balance users.

To safeguard the settings, proceed as follows:

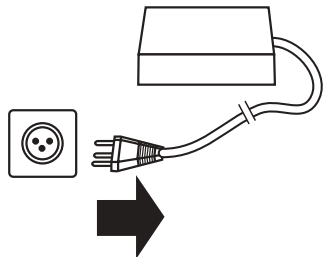

- Disconnect the cable of the AC adapter from the receptacle.
- Remove the cover of the plug-in slot 6 at the rear of your balance.

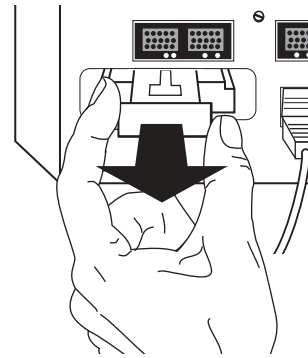

- Grasp the bracket of program cassette **8** and withdraw this carefully from the plug-in slot **6**.

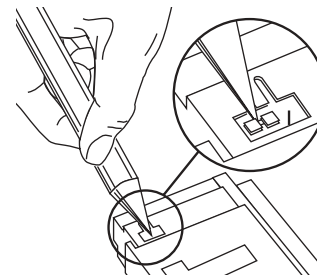

- Remove the jumper with a thin pin or a needle from the contact pins.

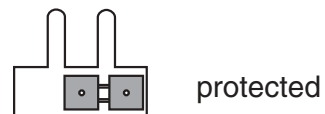
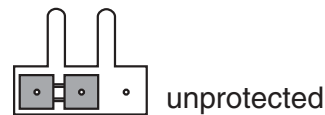

- If you wish to protect your individual settings in the configuration register against inadvertent changes, place the jumper across both contact pins.

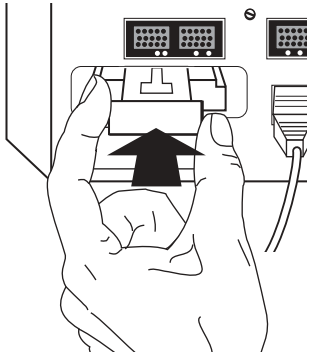

- Slide the program cassette **8** into the plug-in slot **6** up to the stop and replace the cover. Plug the cable of the AC adapter into the receptacle.

If you have secured your settings, the configuration register is no longer accessible and alterations are no longer possible.

- To remove the safeguard, proceed in the reverse sequence.

5 Special applications and functions of your balance

Your balance is also prepared in the best possible way for special cases. Applications and functions built in as standard expand the possibilities of your balance and facilitate the operation. The following section familiarizes you with these applications and functions.

5.1 Your balance can work with two weight units

With your balance you can toggle between two preselected weight units at any time. Section 4.5 of these operating instructions shows you how to select and store these two weight units in the configuration register.

You have, for example, selected “mg” as weight unit 1 and “ct” as weight unit 2 in the configuration register. You can switch between these two units at a keystroke:

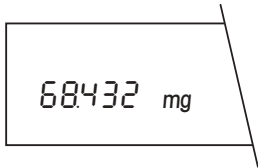

The balance is operating with weight unit 1.

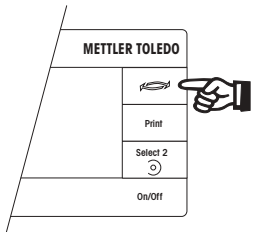

- Press key  briefly and ...

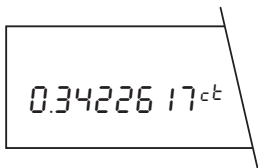

- ...the balance now works with weight unit 2. By pressing the  key again, you can return to weight unit 1.

The table in section 7.6 shows you the conversion factors between the various weight units.

5.2 Your balance also works with percentages and shows plus/minus deviations

This built-in application allows you to weigh in to a **preset value (100%)** and to determine **deviations from a target value**.

So that this application appears in the menu, you must set the unit to percent (%) under the parameter “Weight unit 2” (*Unit 2*) in the “Weight units” (*Unit*) sector of the configuration register as described in Section 4.5.

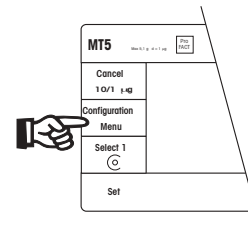

- Press the «**Menu**» key briefly and the balance prompts you to load the **reference weight**.

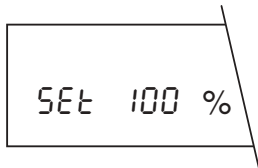

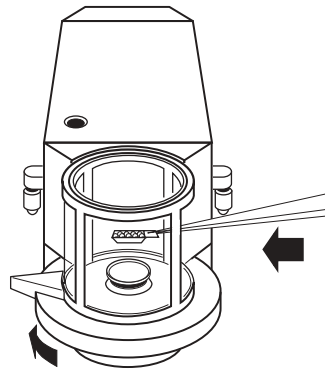

Note: This request appears only if weight unit 2 is set to percent (%).

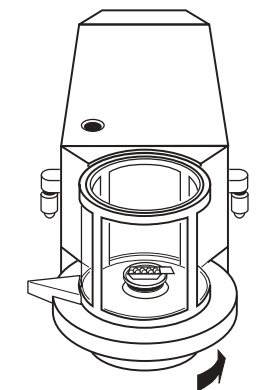

- Open the draft shield and load the reference weight.



- Press the «**Set**» key and the draft shield closes automatically if the automatic door function is switched on. If not, close the draft shield manually or by pressing one of the two keys  or  and then press key «**Set**».

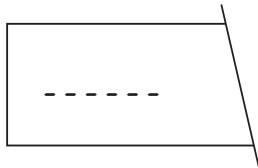

As long as the horizontal dashes are displayed, your balance is weighing the reference weight.

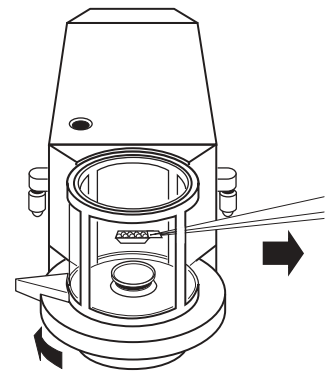

- As soon as the horizontal dashes disappear, the reference weight has been read in and your balance is ready for weighing. If the automatic door function is switched on, the draft shield opens automatically on completion of the weighing process. If not, open it yourself. Remove the reference weight.



The DeltaTrac® now shows a plus and a minus marking that displays the tolerance limits of plus and minus 2.5%.

Now first weigh in coarsely:

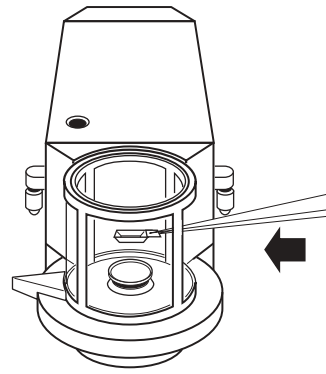

- Place the empty container on the pan and set the balance to zero (taring).

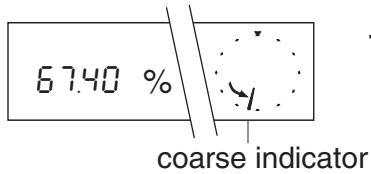

- Add the weighing sample at a steady rate to the container until the coarse indicator on the DeltaTrac® is pointing **vertically downward**. This shows that the approximate target weight has now been reached.

Now perform the **fine weighing**:

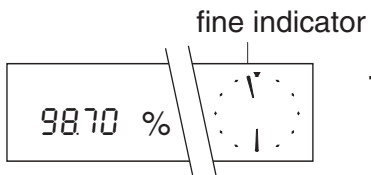

- After the coarse weighing in, you now add the weighing sample carefully until the fine indicator on the DeltaTrac® is pointing **vertically upward**.

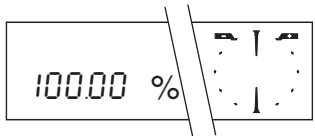

- When the fine and the coarse pointers form a **vertical line**, the set weight is within **±0.25%** of the target.



You also have a fine range available in the weight unit %, in which additional decimal places are displayed.

With the  key you can display **either the percentage or the weight** (see also Section 5.1).

5.3 Do you wish to count pieces?

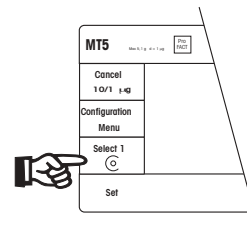
First your balance needs to know that you wish to perform piece counting. You make this setting in the third sector of the configuration register (*Unit*), where you set weight unit 2 (*Unit 2*) to “PCS” (English) or “Stk” (German). This setting is described in Section 4.5.



- Open the draft shield manually or by pressing one of the two keys  or .

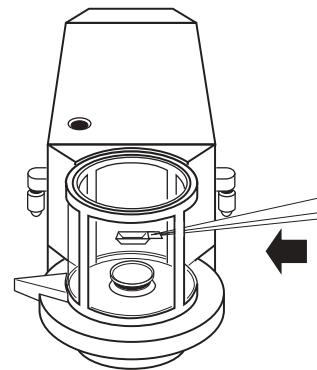

- If you wish to **count into** a container, load the **empty** container.

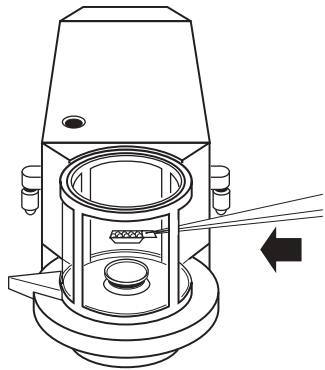

- If you wish to **count out** of a container, load the **full** container.

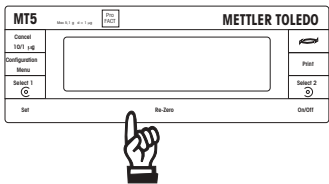

- Set the scale to zero (taring).

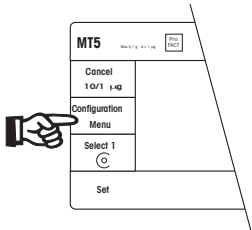

- Your balance now needs the weight of a **reference piece number**. Press the «**Menu**» key briefly.



Note: This menu selection appears only when weight unit 2 is set to piece (*PCS* or *Stk*).

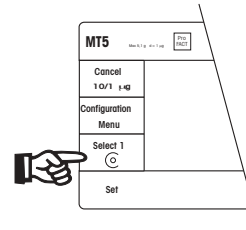

- Select the desired **reference piece number** with the «**Select 1**» key. The following piece numbers are available:

10 20 50 100

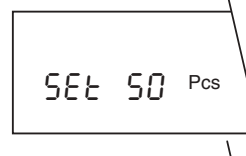
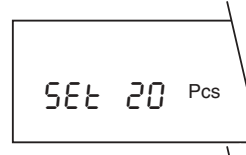
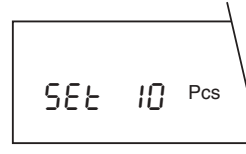

Note: We advise you to select a reference piece number as large as possible since your balance determines the average weight per piece. Since it is seldom the case that all pieces are equally heavy, the reference weight that is stored is naturally more accurate the greater the reference piece number.

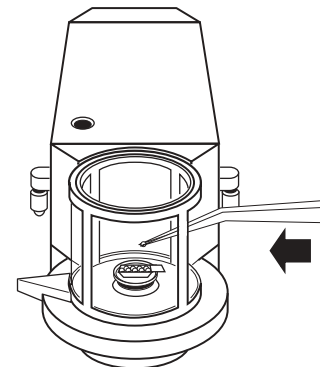

- If you wish to **count into** a container, **add** the selected number of pieces (reference piece number) of the weighing sample to the container.

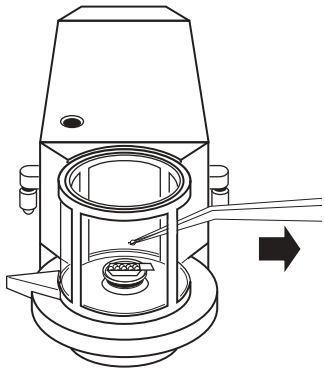

- If you wish to **count out** of a container, **remove** the selected number of pieces from the container.

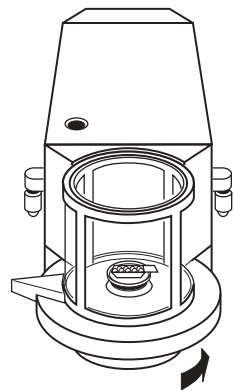

- Press the «**Set**» key, and the draft shield closes automatically if the automatic door function is switched on. If not, close the draft shield manually or by pressing the \odot or \ominus key and then press the «**Set**» key.

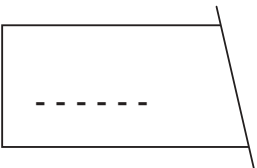

As long as the horizontal dashes are displayed, your balance is weighing the reference weight.

- As soon as the horizontal dashes disappear, the reference piece number and the reference weight have been read in and your balance is ready for counting or weighing.

If the automatic door function is switched on, the draft shield opens automatically on completion of the weighing-in process. If not, open it yourself.

Depending on how you have weighed in the reference weight, you can now:

- **Count into** the container with display of the total number of pieces in the container or...
- ...**count out** of the container with display of the number of pieces removed from the container.

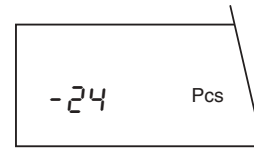
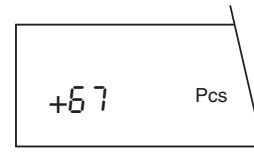

You can use the \leftarrow key to display **either the piece number or the weight** (see also section 5.1).

5.4 How to trigger the adjustment manually

In the factory the balance is preset to proFACT. The MT/UMT balance adjusts and linearizes itself as soon as a change in the ambient conditions makes this necessary. You thus need not concern yourself with the adjustment. But you also have the possibility to trigger the motorized adjustment with the internal adjustment weights at all times at a keystroke. This can be practical if the audio warning beep sounds during a weighing and the adjacent symbol appears in the display. This is how your balance shows you that it would like to adjust itself. You can now either interrupt your work at the next convenient opportunity for about 5 minutes, when the balance will adjust itself, or you yourself can trigger the motorized adjustment by pressing a key.

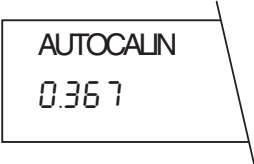

AUTOCALIN
0.367

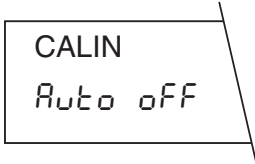

CALIN
Auto OFF

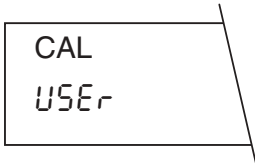

CAL
USER

You select the adjustment mode in sector 2 (*SCALE*) of the configuration register (see Section 4.4). In addition to the **fully automatic self-adjustment**, you have two further adjustment possibilities available:



- You trigger the **automatic adjustment with the internal adjustment weights**, with simultaneous automatic linearization of the measuring range at a keystroke.
- The **manual adjustment with an external adjustment weight**, without linearization of the measuring range.

If you have switched off the automatic self-adjustment, you should adjust the balance occasionally.

Automatic adjustment with the internal adjustment weights at a key-stroke

You have this adjustment mode available if you have set the parameter "adjustment and linearization" in sector 2 of the configuration register (basic settings) either to *CALIN Auto on* or *CALIN Auto off*.

AUTOCALIN
CAL Int

- Repeatedly press the «**Menu**» key briefly until the adjacent display appears.
- Trigger the adjustment procedure by pressing the «**Set**» key. The draft shield now closes automatically if the automatic door function is switched on. If not, close the draft shield manually or by pressing the  or  key.

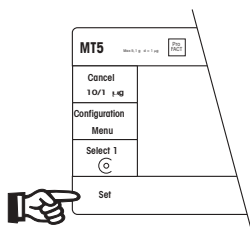

- You can follow the adjustment and linearization procedure in the numerical display and on the DeltaTrac®, and you also hear when the internal weights are loaded.

CAL End

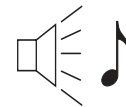



0.000 mg

Completion of the adjustment and linearization process is displayed briefly,...

...the audio warning beep sounds and the balance returns to the weighing mode.

Manual adjustment with an external adjustment weight

You wish to use your own external adjustment weight for the adjustment and have set the parameter proFACT (adjustment and linearization) to *CAL USEr* in sector 2 of the configuration register (basic settings). In this mode, the **automatic adjustment with the built-in adjustment weights is switched off**.

- Repeatedly press the «**Menu**» key briefly until the adjacent display appears.
- Trigger the adjustment procedure by pressing the «**Set**» key. The draft shield now closes automatically if the automatic door function is switched on. If not, close the draft shield manually or by pressing the  or  key.

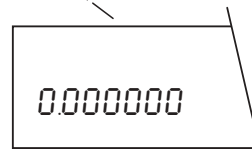
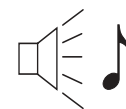
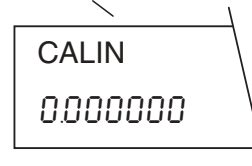
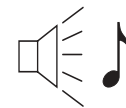
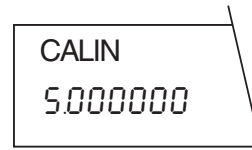
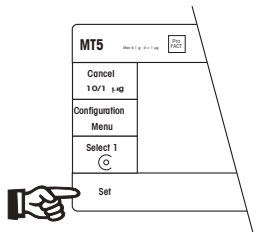

After a short time, the audio warning beep sounds and the requested, model-dependent adjustment weight appears in the display (for example, 5 g in the MT5 case).

- Open the draft shield, load the requested adjustment weight and close the draft shield.
- Wait until the audio warning beep sounds. The display now requests the removal of the adjustment weight.
- Open the draft shield, remove the adjustment weight and close the draft shield.

As soon as the audio warning beep is heard and the adjacent display appears, the adjustment is finished and your balance is again in the weighing mode.

5.5 How to check whether the balance is still adjusted correctly

In the factory, the balance is set to proFACT, professional fully automatic adjustment and linearization technology. A check of the adjustment is not necessary in this mode. If you have selected the automatic adjustment mode with manual triggering (*CALIN Auto OFF*) in sector 2 of the configuration register (see Section 4.4), it is advisable to check the adjustment with the internal adjustment weights occasionally.

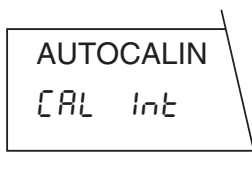
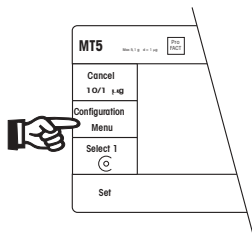

- Select the menu by pressing the «**Menu**» key briefly.
- Repeatedly press the «**Menu**» key briefly until the adjacent display appears.

Note:

This display does not appear if you have set the parameter “adjustment and linearization” to *CAL USER* in the configuration register (adjustment with your own external adjustment weight). Please also see the note at the end of this section.

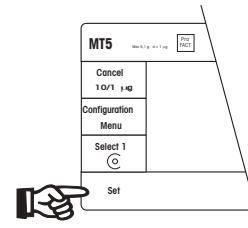
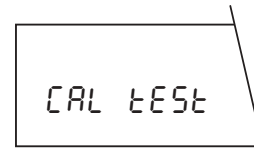

- Select the adjustment test by pressing the «**Select 1**» key.
- Start the test by pressing the «**Set**» key. If the fully automatic door function is switched on, the draft shield now closes automatically. If not, you first close the draft shield manually or by pressing the \odot or \ominus key and then the «**Set**» key.

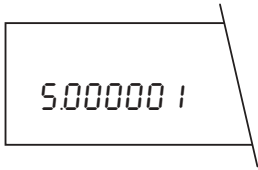

The internal weights are now loaded, without the balance being adjusted, and the current, model-dependent adjustment value displayed, interrupted by the display *tEst*.



- When you have read off the value, abort the test by pressing the «**Set**» or «**Cancel**» key. The balance is then again in the weighing mode.

Notes:

If the deviation of the adjustment weight is more than $\pm 0.00015\%$ (1.5 ppm) from the full load, the balance should be adjusted (see Section 5.4).

If you work with your own, external adjustment weights (parameter “adjustment and linearization” set to *CAL USER* in the configuration register), you can check the adjustment of the balance by loading your own, external adjustment weights.

5.6 How to print out the weighing result

You can output the weighing result via the interface connection **4** on a printer. If you wish to attach a third-party printer, you match the parameters of the data interface to the specifications in the printer handbook (see Section 4.6). You will find further details in the instructions “Bidirectional interface of the METTLER TOLEDO AT/MT/UMT balances”, which is also enclosed.

- In the weighing mode press the «**Print**» key briefly.

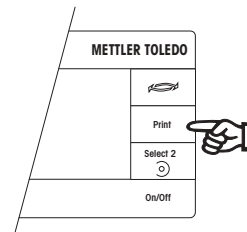

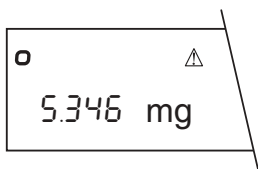

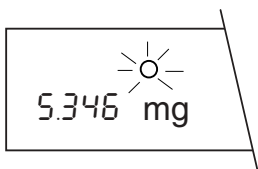

- As soon as the result is stable, it is transferred via the interface connection **4** to the printer. Up to the transmission, the triangle symbol is lit up in the display. If the transmission has not yet taken place, you can abort the procedure by pressing the «**Print**» key again briefly.



After the transmission, the result is kept for about 5 seconds in the display for checking purposes, and a ring symbol flashes at the upper right.

- **Notes:**
The type of transmission depends on the selected data transmission mode, which you have set in the fourth sector of the configuration register (see Section 4.6). If you have selected the *S.Stb* or *S.Auto* mode and the automatic door function is switched on, the draft shield is closed, the result transmitted and

then the draft shield opened again. If not, you close the draft shield manually or by pressing the  or  key.

- The transmission command can also be triggered with the hand or foot switch (available as an accessory).

5.7 You can also operate your balance by remote control

The **complete operation** (keypad and draft shield) as well as the menu and the configuration register of your balance can also be controlled **via a computer**. This allows you to incorporate your balance in an automation system and, for instance, is also suitable for loading by a **robot**.

The draft shield, the zeroing (taring) of the balance and the print command can also be controlled externally via an **electrical contact** (relay, proximity switch). The connections for the electrical contacts **3** are at the rear of your balance.

You will find further information regarding the attachment of an external computer or an electrical contact in the operating instructions “**Bidirectional interface of the METTLER TOLEDO AT/MT/UMT balances**”.

6 Important information regarding your balance

6.1 The AC adapter offers you a space-saving assembly option

You can naturally place the AC adapter supplied anywhere in the vicinity of the balance within the radius of the connection cable. But in addition, the AC adapter also offers you an additional space-saving installation possibility, namely mounting on a wall.

Wall mounting

- Decide on a suitable place for the AC adapter. Take the length of the connection cable into account.

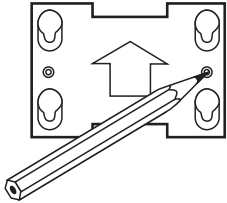

- Use the AC adapter holder as a template to mark out the drill holes.

- Drill the holes and use the dowels in the installation set supplied should the wall material require it. Fix the AC adapter holder such that the arrow is visible and pointing upward.

- Hold the AC adapter so that the connection cable exits from the **top** and position the four feet in the slots in the holder. Hold the connection cable to the **right** while doing so and it will slide into the central slot of the holder automatically.

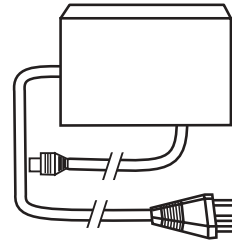
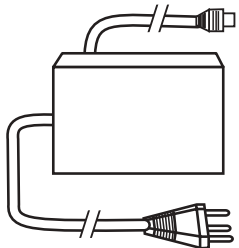
**Note:**

You can also fix the AC adapter so that the connection cable exits from **below**. In this case hold the connection cable to the **left** when engaging the AC adapter.

- Press the AC adapter gently downward to the stop.

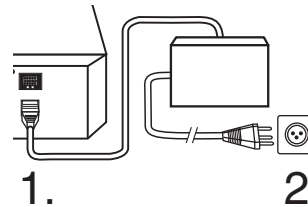

- Connect the AC adapter first to connection socket **9** of the evaluation unit and then to the power supply.

6.2 If you change the location of your balance

If you wish to relocate your balance, there is no need to arrest any parts or controls, but please note the following information:

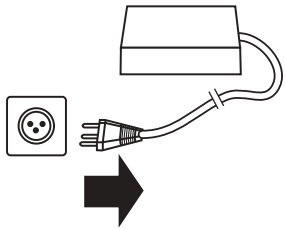

- If the balance is connected to the power supply, disconnect the power cable. There is no need to remove the connection between the weighing cell and the evaluation unit.

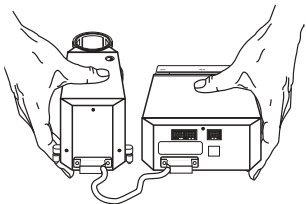

- Carry the balance to the new location. For this, hold the housing of the evaluation unit at the side. Hold the housing of the weighing cell and not the glass draft shield. Ensure that the glass cover of the draft shield does not fall to the floor!

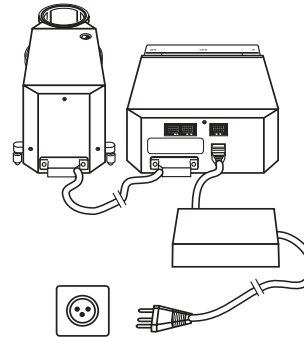

- Reconnect the balance to the power supply.

- Depending on the temperature difference between the old and new location, you should allow the balance to acclimatize for 6 to 12 hours before you start weighing again.

If you transport your balance outside the building, we advise you to use the original packaging.

6.3 A well maintained balance is a joy forever

We have enclosed a brush and cleaning tweezers for cleaning your balance. These aids can be found in drawer **10** on the left of the evaluation unit. To clean the weighing chamber, proceed as follows:

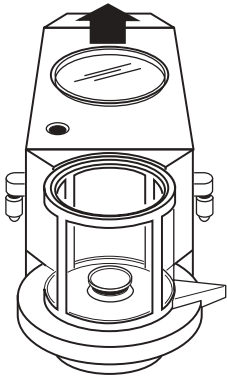

- Remove the glass cover of the weighing chamber.

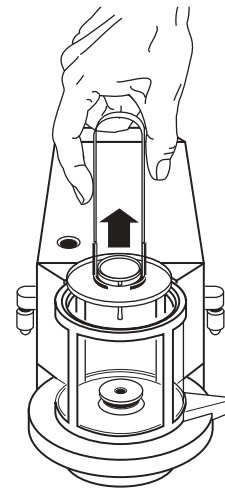

- **MT balances:** Grasp the weighing chamber plate with the holder at the tip of the cleaning tweezers and lift it together with the weighing pan completely out of the weighing chamber.

UMT balances: Grasp the weighing chamber plate with the holder at the tip of the cleaning tweezers and lift it with the weighing pan and the guarding completely out of the weighing chamber.

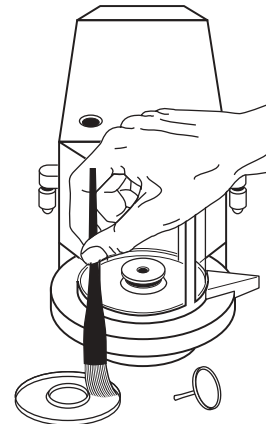

- Clean the weighing chamber plate and the top and bottom of the weighing pan with the brush. Especially ensure that no fibers or dust particles remain on the shaft of the weighing pan.
- Using the cleaning tweezers, first reinstall the weighing chamber plate, then the weighing pan in the balance.
- Replace the glass cover of the draft shield.



Cleaning

The balance housing and the weighing pan are made of high-grade, resistant materials. You can thus use any commercially available cleaning agent for cleaning.

- MT/UMT balances can best be cleaned with a damp cloth.



Cautionary note

Ensure that no liquids can enter the AC adapter or the balance.

6.4 What your balance brings with it

The following accessories are supplied with your balance:

- Protective cover for the display
- AC adapter with holder and installation set
- Operating instructions MT/UMT balances
- Short-form operating instructions MT/UMT balances
- Brochure "Bidirectional data interface of the METTLER TOLEDO AT/MT/UMT balances"
- "Weighing the right way"
- Cleaning brush
- Cleaning tweezers
- Weighing tongs

6.5 Additional information and accessories for your balance

For **below-the-balance weighings** your balance is equipped with an opening for a hanger. Remove the glass cover of the weighing chamber. Tilt the balance to the side and swing the cover of the opening on the underside of the balance to one side. You can now attach a pan or a holder to the horizontal hole underneath the weighing pan.



Do not attach these to either of the two rings!

For the expansion of your balance, for special applications and for different types of weighing problems, a variety of **peripheral units** and **information brochures** are available from METTLER TOLEDO.

7 Any questions?

7.1 What happens if the weight display is unstable?

Since it is not always easy to determine the exact cause of an unstable display the most frequent sources of error are listed below.

You will find detailed explanations in the enclosed booklet “Weighing the right way”.

An unsuitable location

Strong drafts (e.g. from air conditioning systems) or vibrations of the bench are factors that can cause disturbances.

- Look for a suitable location, adapt the vibration adapter to the local conditions (see Section 3.3).

Electrostatic charging of weighing samples and containers

This charging frequently appears in heated rooms with **dry air** (below 40 - 45% rel. humidity) and with weighing samples made of **glass** or **plastic**. The electrical charges generate forces that can disturb the weighing. The small, circular draft shield with its metal framework and the weighing pan are grounded and considerably reduce the electrostatic charging.

- In the simplest case, it may be sufficient to also place the weighing sample in a metal container.

Magnetic weighing samples or containers

-

In simple cases, it may be sufficient to increase the distance between the weighing sample and the weighing pan. For this, place the weighing sample **on** a nonmagnetic metallic (e.g. aluminum) or glass vessel.

Weighing samples or containers that are not at ambient temperature

Weighing samples or containers that are warmer or colder than the ambient temperature of the balance can cause disturbing air currents and buoyancy errors. Weight changes due to the uptake or evolution of surface moisture can also be the cause. These lead to wrong or unstable weighing results.

- Wait until the weighing sample and the container have attained the ambient temperature. Do not touch the weighing sample or the container with your hand (about 35 °C), but use only tweezers or the weighing tongs.

Weighing samples or containers that absorb or evolve moisture readily

All weighing samples or containers made of **wood, cardboard, paper, cork** (e.g. holder for round-bottomed flasks), **plastic** or **rubber** can absorb or evolve enough moisture to make the display unstable and cause display of nonreproducible or wrong weighing results.

- If at all possible, containers made of such material should be replaced by metal or glass vessels. If this is not possible, operations should at least be performed in a room with a constant atmospheric humidity.

Contamination

Powder, liquid or other residues at the edge of the weighing pan or between the weighing pan and the draft cover can lead to unstable displays if the weighing pan no longer has completely unrestricted movement.

- Clean the weighing pan and the draft collar (see Section 6.3).

The weighing process adapter is switched off

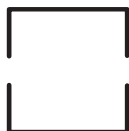

If the weighing process adapter is switched off, the weight display does not always achieve stability when the local conditions are unfavorable and measurements are performed in the fine range.

- Use this setting of the weighing process adapter exclusively for applications in which the **dynamics** of the weighing process are of prime interest (see Section 3.2).

7.2 How can the weighing speed be increased?

The weighing speed or the stabilization time of your balance is influenced considerably by the following factors and settings:

Vibration adapter



If the local conditions allow (see Section 3.3), you can shorten the stabilization time of your balance by setting the medium or small wave symbol of the vibration adapter. Changing the setting of the vibration adapter by one step causes your MT/UMT to react around a third faster.

Readability

If your application allows, you should reduce the readout increments for the last decimal place. The larger the readout increments (e.g. steps of 5 instead of 1), the more rapid the operation of your balance (see Section 4.4).

Automatic stability detection

Your balance achieves stability quicker if you reduce the stability detection. If you select, for example, stage 1 (*ASD -1-*) instead of stage 6 (*ASD -6-*), the balance releases the weighing result as stable decidedly more quickly (see Section 4.4).

Always select the fastest setting in the menu or configuration register that your application allows. You can naturally combine all measures and hence produce a marked increase in the weighing speed of your balance.

7.3 What happens if...?

...the display remains completely blank?

Possible causes are:

- no power line voltage
- power cable not connected
- wrong power line voltage

Check and if necessary rectify the specified error sources. If the balance does not function after switching on with the «**On/Off**» key, contact METTLER TOLEDO service.

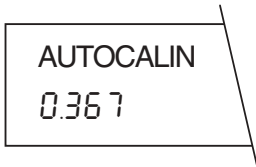

...during a weighing the audio warning beep sounds and the adjacent symbol appears in the display?

- If the fully automatic self-adjustment is switched on (see Section 4.4), your balance shows that it wishes to adjust itself (AUTOCALIN = **Auto**-**matic Calibration** and **Linearization**). But there is no need for you to interrupt your work for this. Your balance will wait until you have not performed any weighings for about 5 minutes and will then adjust and linearize itself. During this process, the symbol flashes.

You also have the possibility, however, to trigger the adjustment immediately with a keystroke. Your method of procedure is described in Section 5.4. The symbol in the display fades when adjustment is ended.

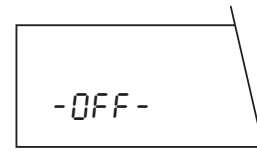
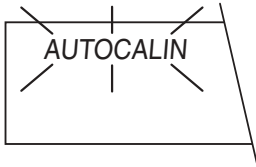

...after connection to the power supply the adjacent display appears?

- You have disconnected your balance from the power supply without previously switching it off by lifting the «**On/Off**» key, or a power outage has interrupted the balance operation. After reconnection to the power supply or when the power is restored, the balance is not switched to standby.
- Press the «**On/Off**» key to switch the balance on again. An extended internal self-test is then run with display of the model designation and the software version. All display segments light up briefly and your balance is then ready for weighing again.

...the display shows overload or underload?

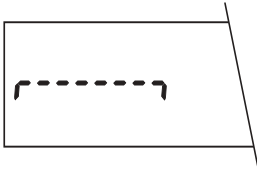

- **Overload** is displayed when the weight of the loaded weighing sample is larger than the weighing range.

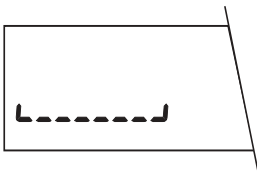

- **Underload** is displayed when the weighing range is not reached. This applies when the weighing pan is missing, or the weighing pan touches the draft collar and no longer has unrestricted movement. In this case switch the balance off, position the weighing pan correctly and then switch the balance on again.

...the display “0.0000” flashes?

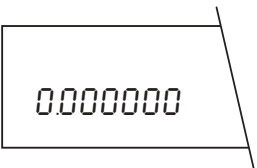

Zero is not defined:

- Place the weighing pan on the balance.
- Remove the load from the weighing pan.

...the status indicators suddenly disappear?

- Depending on the setting in the configuration register, the status indicators **21** are either displayed permanently or only for a few minutes after the balance has been switched on (see Section 4.5).

...the balance returns automatically from the menu or the configuration register to the weighing mode?

- You have selected the menu or the configuration register and not pressed a key for 1 minute. Your balance thus assumes that you do not wish to make any changes and returns to the weighing mode.

...no weighing results or nonsensical characters are printed out on the attached printer?

- To ensure correct functioning of the attached printer, different settings have to be made in the configuration register, including values for the data transmission and the parity (see Section 4.6). Information regarding the correct settings can be found in the handbook of your printer.

...the triangle symbol appears in the display?

- You have pressed the «Print» key. Your balance signals that it is ready to transmit a released weighing result (stability indicator faded) via the interface (e.g. to a printer).

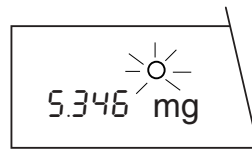
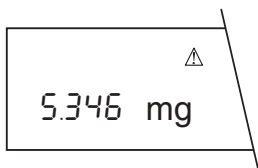

...a flashing circle appears above the weight unit?

- If a weighing result has been transmitted via the interface (with the «Print» key), in fully automatic operation the draft shield opens automatically. So that you can check the result or if need be note it down, the display remains “frozen” for 5 seconds, and this is indicated by the flashing circle.

7.4 What does this error message mean?

- Error messages in the display draw your attention to faulty operation, namely that the balance was not able to perform a procedure properly. Error messages are supported by an audio signal (“twitter”).

Wrong or missing reference weight

- If one of the application units percent (%) or piece (*PCS* or *Stk*) has been selected as weight unit 2, the balance must have a reference weight available. The following errors can appear:
- No reference weight has been loaded.



no rEF

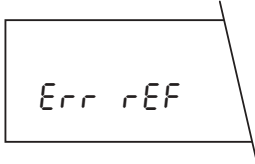

Err rEF

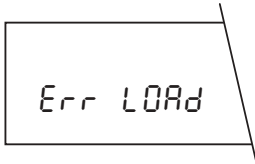

Err LORd

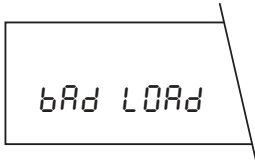

bAd LORd

- A wrong reference weight has been loaded.
- The balance returns automatically to the weighing mode.

The weight lies outside the tolerance

The following causes could be responsible:

- a wrong external adjustment weight.
- the weighing pan is loaded during the adjustment.

The adjustment procedure is aborted automatically and the balance returns to the weighing mode.

- You have started the adjustment test. A weighing sample is still on the weighing pan. Remove it.

Err.unStb

Fault in the adjustment

- The adjustment procedure of the balance has been disturbed.
- The adjustment is automatically aborted and the balance returns to the weighing mode.

Err.tIME

The wait time of 1 minute has run out

This could have the following causes:

- The setting of the automatic stability detection (ASD) is too high. After pressing the «Print», «Re-Zero» or «Set» key (with %, PCS or Stk), stability is not reached within 1 minute.
- The weight for the external adjustment has not been loaded.
- A wrong weight has been loaded.

The corresponding procedure is aborted automatically and the balance returns to the weighing mode.

7.5 What does this term mean?

We have “translated” the most important technical terms for you. References (in italics) show you the section(s) in which you can find further information.

Adjustment

Matching the balance to a reference weight. Adjustment, see also proFACT *Sections 4.4, 5.4 and 5.5*

Adjustment test

Test function which can be called up in the menu to allow **checking** of the adjustment without adjustment actually being performed.
Section 5.5

CAL TEST

Ambient conditions

Local conditions at the location of the balance. The following local conditions can lead to display errors during weighing: unsuitable location, changes in the temperature, atmospheric humidity or the atmospheric pressure, magnetic fields, electrostatic forces, vibrations, drafts caused by air conditioning.

Section 7.1

Application unit

Unit selectable in the configuration register that is used for applications in which not only the weight, but also a quantity derived from it (piece, percent) is determined and displayed.

Sections 4.5, 5.2 and 5.3

Automatic door function

Automatic opening and closing mechanism for the glass draft shield that ensures that the balance and the draft shield are always in the correct position for the next weighing step.

Section 3.4

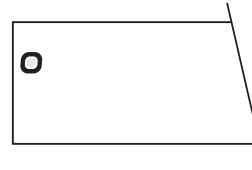
**Automatic stability detection (ASD)**

Continuous automatic check of the weight value for stability. The weight display is considered stable when its change with time lies within a preset limit. Different stages can be configured by the user and correspond to various limits. The stability of the display is attained when the stability detection symbol in the upper left corner of the display fades. Also with Re-Zero (taring) the display is set to zero only when stability has been achieved.

Section 4.4

Autozero

Automatically corrects the zero display if drifting occurs or the weighing pan is contaminated.

Section 4.4

Baud rate

See “Data transmission rate”.

Bit (Binary digit)

Unit used for the information content of a communication.

Section 4.6

Coarse range

In comparison with the fine range, in the coarse range you work with a resolution reduced by a factor of 10. This makes the balance faster and the weighing results are extremely stable.
Sections 2.3 and 2.4

Configuration

The sum total of all settings selected for the parameters in the configuration register.
Section 4

Configuration register

Register with tree-like structure in which operational settings, weight units and much more can be matched to the needs of the user. The configuration register can be protected against inadvertent changes with the aid of the jumper.
Section 4 and pages 78 and 79

Configuring

Changing the settings in the configuration register.
Section 4

Data transmission rate

Specifies the rate at which the data are transferred. Also called baud rate:
1 baud = 1 bd = 1 bit/second.
Section 4.6

DeltaTrac®

Dynamic graphic indicator with 60 radial indicators. Displays the used and remaining weighing range. Graphic complement to the alphanumeric display; also suitable for use as a weighing-in aid.
Sections 2.2 and 5.2

Differential weighing

Determination of the weight of a sample before and after a weight change.

Digit

Display unit; a digit corresponds to a display increment of the last decimal place.

- 1 digit = 1d = 0.001 mg in the coarse range
- 1 digit = 1d = 0.0001 mg in the fine range

See also "Readability"
Section 5.5

Dispensing

Fine weighing in of powder or small quantities of liquid.

Section 3.2

Display

Used for communication between balance and user. Shows weighing results, setting options, etc.

Front fold-out

**Factory setting**

Settings preselected by the manufacturer in the menu or configuration register for normal applications and ambient conditions. Characterized in the configuration register by an asterisk in the upper left corner of the display. Can be changed by the user, but also reset at any time.

Sections 3 and 4

Fine range

In the fine range the balance operates with the greatest possible resolution. This is the range that is normally used in work with microbalances.

Sections 2.3 and 2.4

Foot switch

Available as an accessory in single or twin versions. Control element for zeroing (taring) the display, for triggering the data transmission («Print» key) and for operation of the automatic door function of the draft shield. Frees both hands for operations.

Handshake

Special control lines or data signals for synchronization of the data flow via the serial interface (feedback between sender and receiver).

Section 4.6

Interface

Connector with standardized data transfer between the balance and another component of the system (printer, computer).

Section 4.6

Jumper

Safety device in the program cassette. Rearrangement of contacts blocks the configuration register and thus protects the stored settings against inadvertent change.

Section 4.8

LCD

Liquid **C**ystal **D**isplay. Display which does not itself light up but reflects the ambient light.

Front fold-out

Level

Device which facilitates the horizontal alignment of the balance. Operates on the principle of a spirit level with an air bubble in a liquid. See also "Leveling".

Section 1.2

Leveling

Horizontal aligning of the balance. Should be performed before startup.

Section 1.2

Linearization

Adjustment of the balance characteristic curve. To establish the proportionality between the loaded weight and the display. Performed by the balance for every adjustment in the fully automatic self-adjustment and in the automatic adjustment with the built-in adjustment weights.

Section 4.4

Menu

A menu is generally understood to mean a series of selections which the user can match to his needs. In the menu the user can match the balance to the ambient conditions, adjust the balance and do other adjustments.

Section 3 and pages 78 and 79

Microbalance

Balance with a readability of 1d (1 digit)
= 1 μg = 0.001 mg = 0.000001 g.

Section 1.1

Overload/underload display

Signals the overloading or underloading of the balance through illumination of the horizontal segments in the display.

Section 7.3

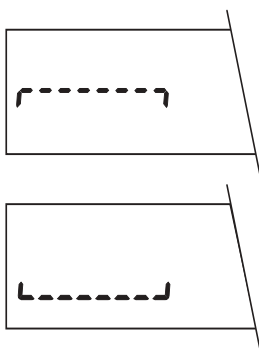
**Parameter**

Part of a sector in the configuration register. Each of the four sectors of the MT/UMT contains parameters (e.g. automatic stability detector, readability, etc.).

Section 4 and pages 78 and 79

Parity

Checking information in the data transmission.

Section 4.6

Percent weighing

Application for the weighing in to a pre-set reference value (= 100%) and with the possibility to display the deviation in percent.

Section 5.2

Piece counting

Weighing application for the determination and display of the piece count of weighing samples of equal weight.

Section 5.3

pro FACT

Fully automatic adjustment and linearization with two internal weights when necessitated by the operating conditions. proFACT: professional Fully Automatic Calibration Technology.

Section 4.4

Program cassette

Cassette with stored microcomputer program needed by the balance for its functioning.

Section 4.8

Readability

Smallest, still distinguishable display difference = 1 d (1 digit).

Section 4.4

Reference weight

Representative reference weight. Needed among other things for the performance of percent weighings and piece counting.

- In percent weighings:
Reference weight = 100%
- In piece counting:
Reference weight = weight of the reference piece number

Sections 5.2 and 5.3

Repeatability

Consistency of the weighing result in several repetitions on the same balance with the same weighing sample and under identical weighing conditions. It is unnecessary that each individual weighing lies within the limits; rather a statistical function is involved. The repeatability is usually expressed in terms of the standard deviations of 10 weighings.

Resolution (resolving power) of a balance

See “Readability”

Re-Zero

International designation for the zeroing of the display and for the zeroing key (the «**Re-Zero**» key of your balance). Also used for zero setting, taring and the tare bar, although the definitions are not identical.

Section 1.3

Sector

Part of the configuration register. The configuration register of your balance comprises four sectors, each of which contains various parameters.

Section 4 and pages 78 and 79

Segment

The smallest part of a display. The display of a letter or a number comprises several segments.

Front fold-out

Self-test

After connection to the power supply, the balance automatically performs a test of its functions.

Section 1.3

Stability detection

See „Automatic stability detection“.

Stabilization time

Also known as weighing speed. It is defined as the time between the loading of the weighing sample on the weighing pan and the attainment of stability of the weight display (see also “Automatic stability detection”). The stabilization time can be matched to special needs with the vibration adapter being the most important influencing factor.

Sections 3.3, 4.4 and 7.2

Standby

Wait condition. Balance is in operational readiness (connected to the power supply via the AC adapter), but not switched on, i.e. the display is dark, only the standby symbol is lit up.

Section 1.3

Status indicators

Symbols that show the most important settings (vibration adapter, weighing process adapter). The symbols can be displayed permanently or for just a few minutes after switching on the balance.
Section 4.5

Tare weight

Weight of a container, vessel or the packing that should not be taken into account in the weighing.
Section 1.3

Target weight

See “Reference weight”.

Taring

Compensation of tare weights, i.e. setting the display of the balance with loaded tare weight to zero. Often called zeroing, zero setting or re-zero.
See also “Re-zero”.
Section 1.3

Ultra-microbalance

Balance with a readability of 1d (1 digit)
= 0.1 µg = 0.0001 mg = 0.0000001 g.



Vibration adapter

Possibility to adapt the balance to the local conditions prevailing at the weighing station. Set in the menu.
Section 3.3

Wait condition

See “Standby”

Weighing-in aid

See “DeltaTrac®”.

Weighing mode

Your balance is ready for weighing operations, i.e. it will display the weighing result and is not in the menu, the configuration register or the standby state.



Weighing process adapter

Possibility to adapt the balance to special types of weighing; set in the menu.
Section 3.2

Weighing speed

See “Stabilization time”.

Weight unit

Unit (e.g. g, mg, ct, etc.) that can be selected in the configuration register.

Section 4.5

Zeroing

See “Taring” and “Re-Zero”.

7.6 How are weight units converted?

The following table will facilitate the conversion between the weight units available for your balance.

	Gram g	Milligram mg	Microgram µg	Carat ct/C.M. (metr.) koil	Pennyweight dwt	Grain GN	Momme mo
1 g =	1	1'000	1'000'000	5	0.6430149314	15.432358353	0.2666666667
1 mg =	0.001	1	1'000	0.005	0.0006430149	0.0154323584	0.0002666667
1 µg =	0.000001	0.001	1	0.000005	0.0000006430	0.0000154323	0.0000002667
1 ct/C.M. =	0.2	200	200'000	1	0.1286029863	3.0864716706	0.0533333333
1 dwt =	1.55517384	1'555.17384	1'555'173.84	7.7758692	1	24	0.414713024
1 GN =	0.06479891	64.79891	64'798.91	0.32399455	0.0416666667	1	0.0172797093
1 mo =	3.75	3'750	3'750'000	18.75	2.4113059926	57.871343824	1

7.7 Where will I find details of...?

The following index shows you the page number of these instructions on which you will find the information appropriate to a particular theme. The page numbers in bold print refer to the most important information for the specific search word.

Absolute weighing	17
AC adapter	4, 51
Accessories	55
Adjustment	29, 45, 47, 64, 65
Adjustment mode	30, 45, 48
Adjustment weight	47
Adjustment test	48
Application unit	31, 66
Applications	11, 14, 16, 18, 28, 39
Automatic door function	20, 66
Automatic door operation	20
Automatic stability detection	26, 66
Autozero	28, 66

Beeper setting	33
Below-the-balance weighing	56
Cleaning	54
Coarse range	11
Configuration register	21, 67
Data interface	33
Dispensing	17
Draft shield	9
Drop symbol	17
DeltaTrac®	11, 41, 67
Electrostatic charging	57
Error message	64
External adjustment weight	30, 47
Factory setting	24, 25, 68
Fine dispensing	17
Fine range	11, 68
Glass draft shield	9
Interface	33, 69
Jumper	38

Linearization	29, 45, 69	Self-adjustment, fully automatic	30, 45
Magnetic weighing samples or containers	57	Self-test	5, 8, 72
Manual adjustment	45, 47	Setting options	13, 21
Menu	13	Stability detection	26, 66, 72
Operational setting	23, 25	Stabilization time	59, 72
Overload	62	Standby	7, 72
Percent	40	Status indicators	32, 73
Percent weighing	40, 70	Switching off the balance	7, 61
Piece counting	20, 42, 70	Taring	6, 73
Power outage	8, 61	Underload	62
Printer	37, 49	Unstable display	19, 56
proFACT	29, 45, 71	Vibration adapter	18, 73
Program cassette	38, 71	Vibrations	18
Readability	27, 71	Wait condition	5, 8, 73
Readout increment	27	Wave symbol	18
Reference weight	40, 43, 71	Weighing in	17
Repeatability	27, 71	Weighing mode	5, 73
Resolution	11, 72	Weighing process adapter	17, 73
Re-Zero	72	Weighing speed	28, 59, 67, 73
		Weight unit	31, 39, 74

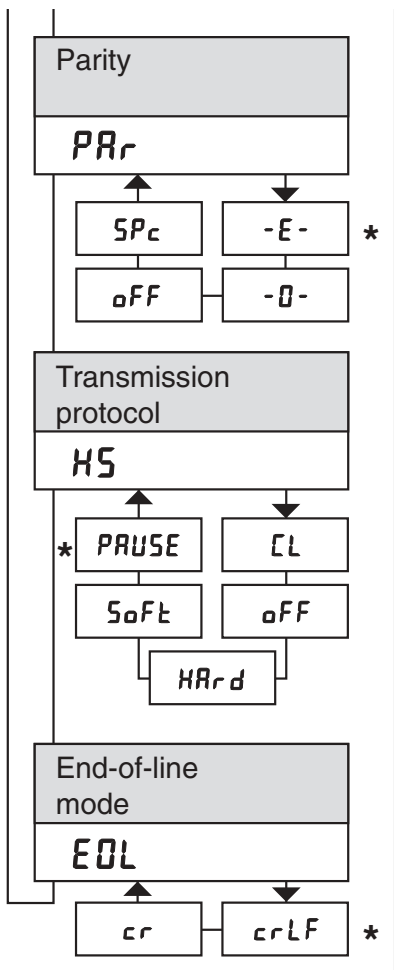
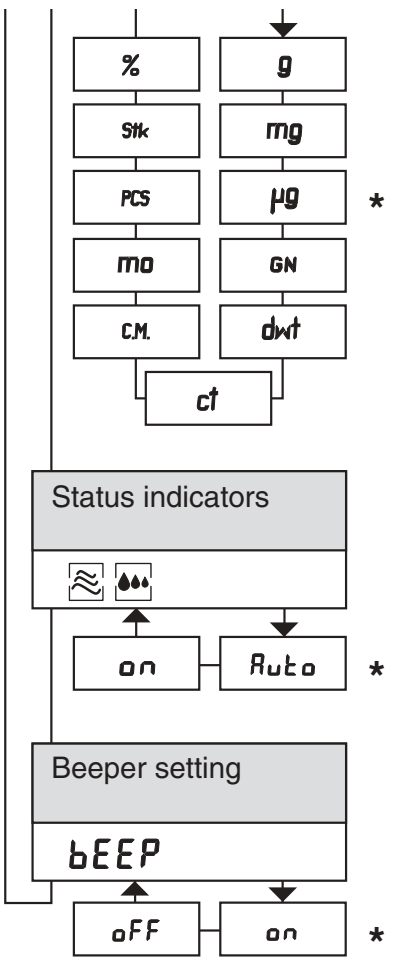
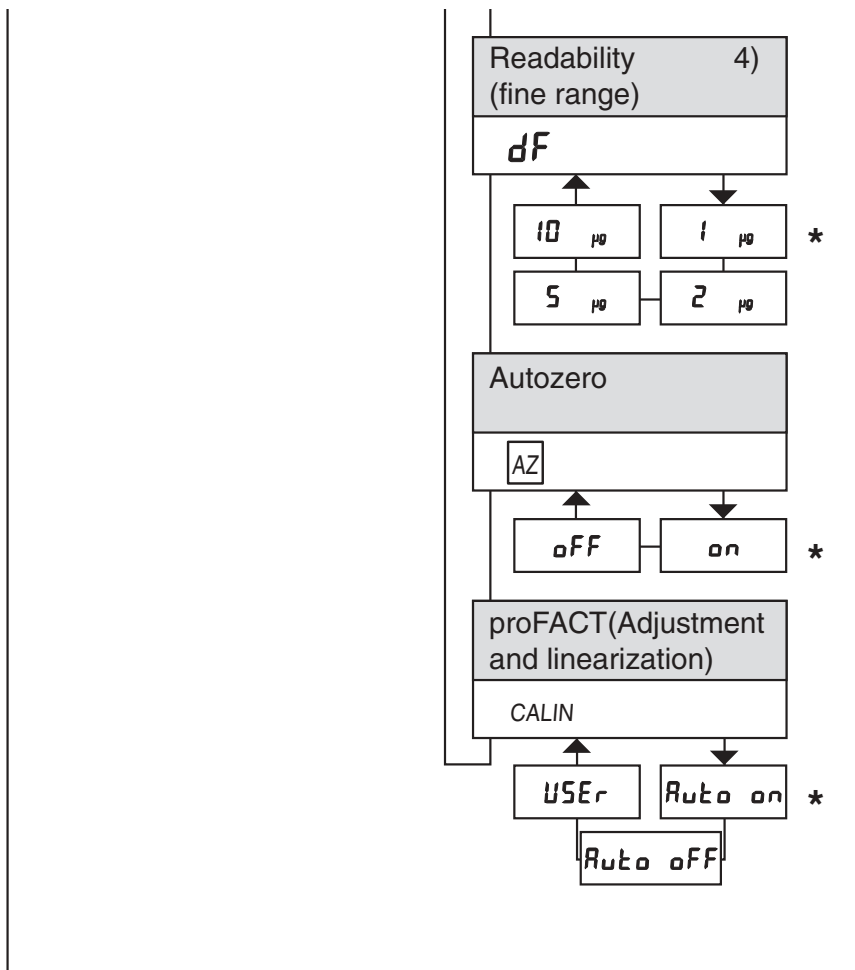
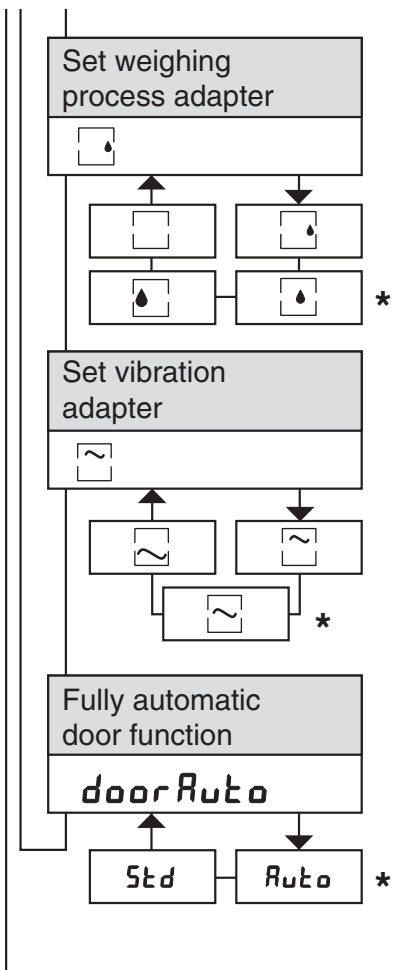

Menu	
	Selection of the menu Selection of the menu options
	Selection of the settings
	Cancellation of the changes and return to the weighing mode
	Saving of the settings and return to the weighing mode
	Switching off the balance by pressing key upward

Configuration register	
	Selection of the config. register Selection of the sectors
	Selection of the parameters
	Selection of the settings
	Cancellation of the changes and return to the weighing mode
	Saving of the current configuration and return to the weighing mode

- 1) Appears only if weight unit 2 is set in the configuration register to percent (%) or piece (Stk or PCS).
 - 2) Appears only if the internal adjustment (Auto Off) is set in the configuration register.
 - 3) Appears only if the external adjustment (USEr) is set in the configuration register.
 - 4) The following appears with the UMT2:
d = 1 µg *, 2 µg, 5 µg, 10 µg
dF = 0.1 µg *, 0.2 µg, 0.5 µg, 1 µg
- * Factory setting

Technical Specifications

Modell	UMT2	UMT5 Comparator	MT 5
Readability	0.1 µg	0.1 µg	1 µg
Weighing capacity	2100 mg	5100 mg	5100 mg
Taring range (by subtraction)	0...2100 mg	0...5100 mg	0...5100 mg
Repeatability (s) 0...2 g	0.25 µg	0.25 µg	0.8 µg
Repeatability (s) 2...5 g		0.4 µg	0.9 µg
Linearity	±1 µg	±4 µg	±4 µg
Linearity referred to 500 mg	±0.5 µg	±2 µg	±2 µg
Stabilization time (typical)	10, 16, 24 s	15, 20, 30 s	9, 12, 16 s
	Corresponding to setting of vibration adapter.		
Built-in adjustment weights	2 x 1 g	2 x 2.5 g	2 x 2.5 g
	Measured to ±5 µg at an air density of 1200 mg/l on virtual mass with density 8.0 g/cm ³ .		
Adjustment proFACT	Fully automatic motorized self-adjustment with two built-in weights The accuracy of the adjustment depends on the geographic location and the height above sea level.		
Adjustment with external weight:	2 g	5 g	5 g
Display with Deltatrac®	LCD (liquid crystal)		
Display sequence	0.2...0.4 s variable		
Sensitivity drift (5...40°C)	Maximum deviation with automatic self-adjustment proFACT ±0.00015%, (with automatic self-adjustment switched off) 1 ppm/°C.		
Linearization	Automatic self-linearization of the weighing curve (simultaneously with motorized adjustment proFACT).		
Data interface	CL and RS232C, bidirectional, built in as standard, all lines galvanically separated.		
Glass draft shield	Automatic motorized opening or at a keystroke.		
Equipment designed test conditions	P: 115 V or 230 V, admissible voltage fluctuations: -20%...+15%, frequency: 50/60 Hz, max. power consumption 15.5W.		
Power supply (national codes)	S: 12.8 V=, 6.5 V=, 10.8 V=, 16.7 V= Pollution degree 2. Overvoltage category II. Temperature: 5...40 °C. max. relative atmospheric humidity: 80% for temperatures up to max. 31 °C linearly decreasing to 50% at 40 °C. Height: 6000m. Use only indoors in closed rooms.		
Weighing pan with feedthrough for below-the-balance weighing	ø 16 mm	ø 16 mm	ø 27 mm
	Surface-treated aluminum		
Measures (W x L x H)	Cell 128 x 287 x 113, evaluation unit 202 x 294 x 92 mm		
AC adapter (W x L x H)	115 x 140 x 53 mm		
Weight	Cell 2.4 kg, evaluation unit 2.5 kg, AC adapter 1.2 kg		